



Catalog | 2016

# Pilot devices The core offering

# ABB pilot devices

## How we are helping the industry

### High reliability

"ABB's pilot devices are never failing, regardless of environment. That is 100% reliability."

Duztech, OEM, Sweden

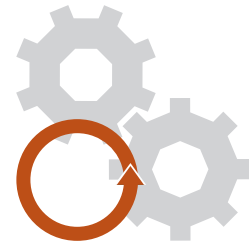

### Easy to install

"Thanks to ABB's pilot devices we can easily make customer specific changes in the last minute."

EA Elautomation, panel builder, Sweden and Lithuania



### Global availability

"Thanks to ABB we have shorted our customer response time from 2 months to 1 day."

LED controls, distributor, United Kingdom

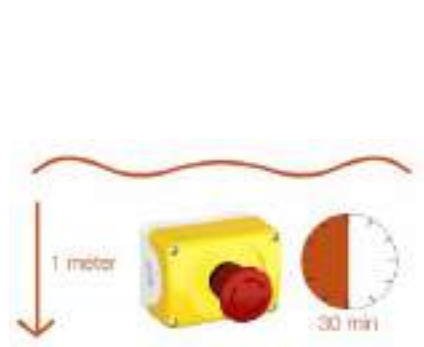

**Water and dust proof according to IP67**  
Our IP67 classed pilot devices can sustain the pressure of submersion to one meter during 30 min.

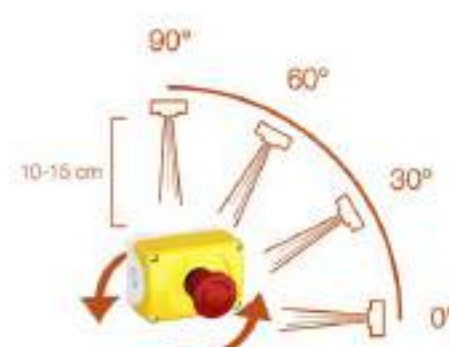

**Tough and robust according to IP69K**  
Our IP69K classed pilot devices can withstand intensive cleaning and rough treatment and are perfect for outdoor installations.



**Secured reliability with wiping action**  
All our contacts have built-in wiping action that cleans the contact every time it is being used.



## Duztech's mist-cannons keeps the air free from dust on tough worksites

Duztech is a Swedish equipment manufacturer that builds and lease mist-cannons for tough environments like building demolition sites. ABB's pilot devices are an integral and reliable part of operating the mist-cannons that keep the air dust free.

### 100% reliability

Duztech reports that none of ABB pilot devices has been broken from conventional use.

# ABB pilot devices

## The core offering

You are holding our Core offering catalog for pilot devices. This is a reduced catalog presenting only the products that you are probably most interested in, while leaving out the rest. This will make it easier to do selection. For our complete offering of pilot devices, please see the Complete catalog.



### Core offering

- Most popular variants of our pilot devices
- Simplified selection for general applications

### Complete offering

- Our complete offering of pilot devices
- Including all variants in our offering

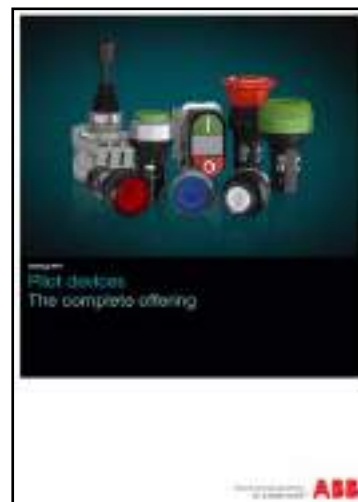

# ABB pilot devices

## Table of contents

### Modular range

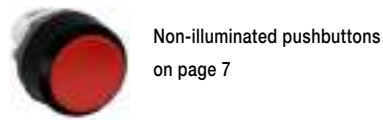

Non-illuminated pushbuttons on page 7



Illuminated pushbuttons on page 7



Non-illuminated double pushbuttons on page 8



Illuminated double pushbuttons on page 8



Heavy duty pushbuttons for 30 mm mounting hole on page 8



Non-illuminated mushroom pushbuttons on page 9



Reset pushbuttons on page 9



Pilot lights on page 10



Non-illuminated emergency stop pushbuttons on page 10



Illuminated emergency stop pushbuttons on page 10



Non-illuminated selector switches on page 11



Illuminated selector switches on page 11



Key-operated selector switches on page 12



Potentiometers on page 13



Joysticks IP67 and IP69K on page 13



Toggle switches on page 13

### Accessories for modular range



Assemblies on page 14



### Compact range



Non-illuminated pushbuttons on page 19



Illuminated pushbuttons on page 19



Heavy duty pushbuttons on page 20



Non-illuminated emergency stop pushbuttons on page 20



Pilot lights on page 21



Buzzers on page 21



Non-illuminated selector switches on page 22

### Accessories for compact range



Accessories on page 22



# Modular range Introduction

The modular range is our most versatile range of operators with high level of flexibility and market leading electrical ratings. The perfect solution for almost every application.



## High reliability

- High electrical rating
- Wiping action to keep good connectivity even in tough environments
- IP66 / Type 1, 3R, 4, 4X, 12, 13



## Easy to install

- Tool-free installation with snap-on contact blocks
- Easy to do last-minute changes of both front and contacts
- Up to 6 contacts

# Modular range Non-illuminated pushbuttons



**How to order:**  
See page "Assemblies" on page 14.

Color	Bezel	Type	Order code	Pkg qty
<b>Momentary flush pushbutton</b>				
● Red	Black plastic	MP1-10R	1SFA611100R1001	10
● Red	Chrome plastic	MP1-20R	1SFA611100R2001	10
● Red	Chrome metal	MP1-30R	1SFA611100R3001	10
● Green	Black plastic	MP1-10G	1SFA611100R1002	10
● Green	Chrome plastic	MP1-20G	1SFA611100R2002	10
● Green	Chrome metal	MP1-30G	1SFA611100R3002	10
● Yellow	Black plastic	MP1-10Y	1SFA611100R1003	10
● Blue	Black plastic	MP1-10L	1SFA611100R1004	10
○ White	Black plastic	MP1-10W	1SFA611100R1005	10
● Black	Black plastic	MP1-10B	1SFA611100R1006	10
● Black	Chrome plastic	MP1-20B	1SFA611100R2006	10
● Black	Chrome metal	MP1-30B	1SFA611100R3006	10
○ Clear	Black plastic	MP1-10C	1SFA611100R1008	10
<b>Maintained flush pushbutton</b>				
● Red	Black plastic	MP2-10R	1SFA611101R1001	10
<b>Momentary extended pushbutton</b>				
● Red	Black plastic	MP3-10R	1SFA611102R1001	10
● Green	Black plastic	MP3-10G	1SFA611102R1002	10
● Black	Black plastic	MP3-10B	1SFA611102R1006	10
○ Clear	Black plastic	MP3-10C	1SFA611102R1008	10

# Illuminated pushbuttons



**How to order:**  
See page "Assemblies" on page 14.

Color	Bezel	Type	Order code	Pkg qty
<b>Momentary flush pushbutton</b>				
● Red	Black plastic	MP1-11R	1SFA611100R1101	10
● Red	Chrome plastic	MP1-21R	1SFA611100R2101	10
● Red	Chrome metal	MP1-31R	1SFA611100R3101	10
● Green	Black plastic	MP1-11G	1SFA611100R1102	10
● Green	Chrome plastic	MP1-21G	1SFA611100R2102	10
● Green	Chrome metal	MP1-31G	1SFA611100R3102	10
● Yellow	Black plastic	MP1-11Y	1SFA611100R1103	10
● Blue	Black plastic	MP1-11L	1SFA611100R1104	10
○ White	Black plastic	MP1-11W	1SFA611100R1105	10
○ Clear	Black plastic	MP1-11C	1SFA611100R1108	10
<b>Maintained flush pushbutton</b>				
● Red	Black plastic	MP2-11R	1SFA611101R1101	10
● Green	Black plastic	MP2-11G	1SFA611101R1102	10
<b>Momentary extended pushbutton</b>				
● Red	Black plastic	MP3-11R	1SFA611102R1101	10
● Green	Black plastic	MP3-11G	1SFA611102R1102	10
○ White	Black plastic	MP3-11W	1SFA611102R1105	10



For more pilot devices products  
please see the complete catalog  
1SFC151005C0201.

# Modular range

## Non-illuminated double pushbuttons



MPD2-11B

### How to order:

See page "Assemblies" on page 14.

Upper button	Lower button	Type	Order code	Pkg qty
<b>Flush pushbutton</b>				
● Green	● Red			
No text	No text	MPD1-11B	1SFA611130R1106	10
	O	MPD2-11B	1SFA611131R1106	10
<b>Extended lower pushbutton</b>				
● Green	● Red			
	O	MPD13-11B	1SFA611142R1106	10
START	STOP	MPD15-11B	1SFA611144R1106	10

## Illuminated double pushbuttons



MPD13-11G



MPD1-11R

### How to order:

See page "Assemblies" on page 14.

Upper button	Lower button	Indicator light	Type	Order code	Pkg qty
<b>Flush lower pushbutton</b>					
● Green	● Red				
No text	No text	● Red	MPD1-11R	1SFA611130R1101	10
	O	● Green	MPD2-11G	1SFA611131R1102	10
	O	● Yellow	MPD2-11Y	1SFA611131R1103	10
No text	No text	○ Clear	MPD1-11C	1SFA611130R1108	10
	O	○ Clear	MPD2-11C	1SFA611131R1108	10
<b>Extended lower pushbutton</b>					
● Green	● Red				
	O	● Green	MPD13-11G	1SFA611142R1102	10
START	STOP	○ Clear	MPD15-11C	1SFA611144R1108	10

## Heavy duty pushbuttons for 30 mm mounting hole



KP6-40R

### Description

The heavy duty pushbutton for 30 mm hole is a robust and compact pushbutton for use in cold, hot, damp, oily and other tough environments. Suitable especially for hydraulic lifts, compact pendant controllers and pushbutton stations.

### How to order:

See page "Assemblies" on page 14. Holder not needed.

Color	Type	Order code	Pkg qty
<b>Heavy duty pushbutton</b>			
● Red	KP6-40R	1SFA616105R4001	1
● Green	KP6-40G	1SFA616105R4002	1
● Black	KP6-40B	1SFA616105R4006	1



KP6-40G



KP6-40B



# Modular range

## Non-illuminated mushroom pushbuttons



MPM1-10B

**How to order:**  
See page "Assemblies" on page 14.

Color	Type	Order code	Pkg qty
<b>Momentary, Ø 40 mm</b>			
● Red	MPM1-10R	1SFA611124R1001	10
● Black	MPM1-10B	1SFA611124R1006	10

## Reset pushbuttons



KPR3-104B

Color	Text	Type	Order code	Pkg qty
<b>Flush reset pushbutton with shaft (flexible joint not included)</b>				
● Black	No text	KPR3-100B	1SFA616162R1006	10
● Black	RESET	KPR3-104B	1SFA616162R1046	10
● Blue	R	KPR3-101L	1SFA616162R1014	10
○ White	R	KPR3-101W	1SFA616162R1015	10

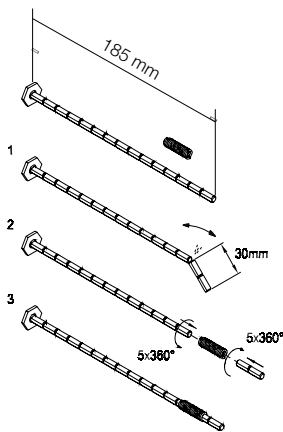

For more pilot devices products  
please see the complete catalog  
1SFC151005C0201.

# Modular range

## Non-illuminated emergency stop pushbuttons

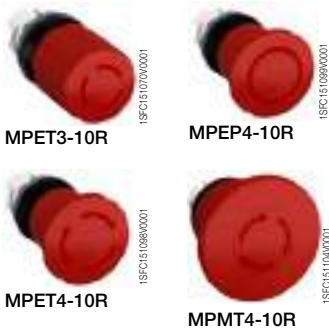

**How to order:**  
See page "Assemblies" on page 14.

Description	Release method	Type	Order code	Pkg qty
<b>Ø 30 mm</b>				
● Red	Twist release	MPET3-10R	1SFA611520R1001	1
<b>Ø 40 mm</b>				
● Red	Twist release	MPET4-10R	1SFA611523R1001	1
● Red	Pull release	MPEP4-10R	1SFA611524R1001	1
● Red	Key release code 71/ronis 455	MPEK4-11R	1SFA611525R1101	1
<b>Ø 60 mm</b>				
● Red	Twist release	MPMT4-10R	1SFA611513R1001	1

## Illuminated emergency stop pushbuttons



**How to order:**  
See page "Assemblies" on page 14.

Description	Release method	Type	Order code	Pkg qty
<b>Ø 40 mm</b>				
● Red	Twist release	MPMT3-11R	1SFA611510R1101	1
<b>Ø 60 mm</b>				
● Red	Twist release	MPMT4-11R	1SFA611513R1101	1

## Pilot lights



**How to order:**  
See page "Assemblies" on page 14.

Color	Type	Order code	Pkg qty
<b>Pilot lights</b>			
● Red	ML1-100R	1SFA611400R1001	10
● Green	ML1-100G	1SFA611400R1002	10
● Yellow	ML1-100Y	1SFA611400R1003	10
● Blue	ML1-100L	1SFA611400R1004	10
○ White	ML1-100W	1SFA611400R1005	10
○ Clear	ML1-100C	1SFA611400R1008	10

# Modular range Non-illuminated selector switches



M2SS1-10B









1SFC15130W001



M2SS4-10B

1SFC151219W001

**How to order:**  
See page "Assemblies" on page 14.

Description	Color	Bezel	Type	Order code	Pkg qty
<b>2 position, short handle</b>					
 Maintained	● Black	Black plastic	M2SS1-10B	1SFA611200R1006	10
 Maintained	● Black	Black plastic	M2SS2-10B	1SFA611201R1006	10
	● Black	Chrome plastic	M2SS2-20B	1SFA611201R2006	10
	● Black	Chrome metal	M2SS2-30B	1SFA611201R3006	10
<b>3 position, short handle</b>					
 Maintained	● Black	Black plastic	M3SS1-10B	1SFA611210R1006	10
	● Black	Chrome plastic	M3SS1-20B	1SFA611210R2006	10
	● Black	Chrome metal	M3SS1-30B	1SFA611210R3006	10
 Momentary, spring return from A to B and from C to B	● Black	Black plastic	M3SS2-10B	1SFA611211R1006	10
 Momentary, spring return from C to B	● Black	Black plastic	M3SS2-10B	1SFA611212R1006	10
 Momentary, spring return from A to B	● Black	Black plastic	M3SS7-10B	1SFA611216R1006	10
<b>2-position, long handle</b>					
 Maintained	● Black	Black plastic	M2SS4-10B	1SFA611203R1006	10
 Maintained	● Black	Black plastic	M2SS5-10B	1SFA611204R1006	10
<b>3-position, long handle</b>					
 Maintained	● Black	Black plastic	M3SS4-10B	1SFA611213R1006	10



# Illuminated selector switches



M2SS1-11G

1SFC15141W002

**How to order:**  
See page "Assemblies" on page 14.

Description	Color	Bezel	Type	Order code	Pkg qty
<b>2-position, short handle</b>					
 Maintained	● Green	Black plastic	M2SS1-11G	1SFA611200R1102	10
 Maintained	● Green	Black plastic	M2SS2-11G	1SFA611201R1102	10
<b>3-position, short handle</b>					
 Maintained	● Green	Black plastic	M3SS1-11G	1SFA611210R1102	10







For more pilot devices products  
please see the complete catalog  
1SFC151005C0201.

# Modular range

## Key-operated selector switches



**How to order:**  
See page "Assemblies" on page 14.

Description	Bezel	Type	Order code	Pkg qty
<b>2-positions</b>				
<b>Maintained (The key can be removed in both positions)</b>				
 Key release code 71/ronis 455	Black plastic	M2SSK1-101	1SFA611280R1001	1
<b>Maintained (The key can be removed in position B only)</b>				
 Key release code 71/ronis 455	Black plastic	M2SSK2-101	1SFA611281R1001	1
<b>Momentary, spring return from C to B (The key can be removed in position B only)</b>				
 Key release code 71/ronis 455	Black plastic	M2SSK3-101	1SFA611282R1001	1
<b>3-positions</b>				
<b>Maintained (The key can be removed in all positions)</b>				
 Key release code 71/ronis 455	Black plastic	M3SSK1-101	1SFA611283R1001	1
<b>Momentary, spring return from A to B and from C to B (The key can be removed in position B only)</b>				
 Key release code 71/ronis 455	Black plastic	M3SSK3-101	1SFA611285R1001	1

### Position scheme for switches

**Key-operated selector switch 2-pos**  
Contacts actuated

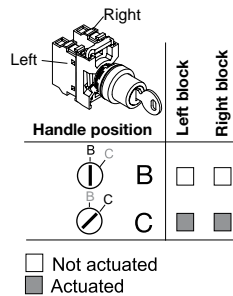

**Key-operated selector switch 3-pos**  
Contacts actuated

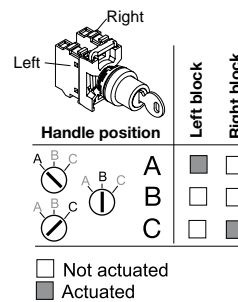

**Selector switch 2 pos and 3-pos**  
Contacts actuated

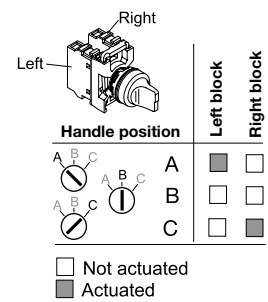

**Toggle switch 2-pos**  
Contacts actuated

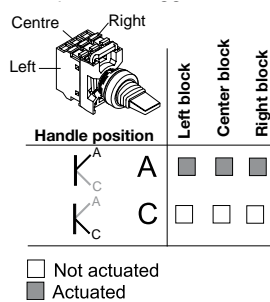

**Toggle switch 3-pos**  
Contacts actuated

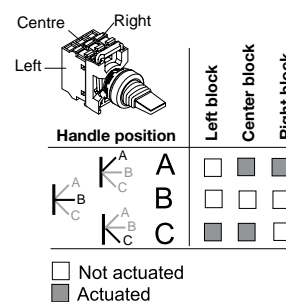

For more pilot devices products  
please see the complete catalog  
1SFC151005C0201.

## Modular range Potentiometers



MT-105B

1SFC151139V0001

Description	Bezel	Type	Order code	Pkg qty
<b>Complete potentiometers</b>				
Black knob with integrated position indication and marking in white				
With resistor 5 kohm	Black plastic	MT-105B	1SFA611410R1056	1
With resistor 5 kohm	Chrome metal	MT-305B	1SFA611410R3056	1
With resistor 10 kohm	Black plastic	MT-110B	1SFA611410R1106	1
With resistor 10 kohm	Chrome metal	MT-310B	1SFA611410R3106	1



## Toggle switches



MTS2-10B

1SFC151132V0001

**How to order:**  
See page "Assemblies" on page 14.

Description	Bezel	Type	Order code	Pkg qty
<b>2-positions</b>				
 Maintained	Black plastic	MTS1-10B	1SFA611300R1006	10
<b>3-positions</b>				
 Momentary, spring return from A to B and from C to B	Black plastic	MTS2-10B	1SFA611301R1006	10

## Joysticks IP67 and IP69K



MJS2-60B

1SFC151127V0001

**How to order:**  
See page "Assemblies" on page 14.

Description	Bezel	Type	Order code	Pkg qty
<b>Joystick</b>				
2-position momentary	Chrome metal	MJS2-60B	1SFA611702R6006	1
4-position momentary	Chrome metal	MJS6-60B	1SFA611706R6006	1

# Modular range Assemblies

## Non-illuminated pilot devices

### Alternative 1:

Operator + Holder + Contact block

### Alternative 2:

Operator + Holder with contact blocks

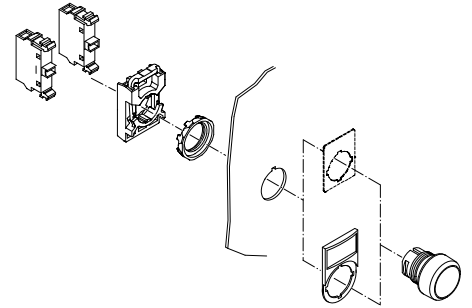

## Illuminated pilot devices

### Alternative 3:

Operator + Holder + Contact block + LED block

### Alternative 4:

Operator + Holder with contact blocks + LED block

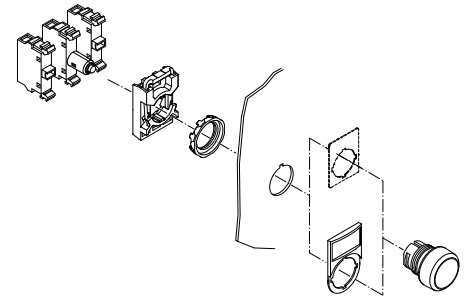

MCBH-00



MCBH5-00

## Holders

Description	Type	Order code	Pkg qty
<b>Holder</b>			
3-positions	MCBH-00	1SFA611605R1100	10
5-positions*	MCBH5-00	1SFA611601R1100	10

\* Note: Double contact blocks are required on side positions



MCB-01



MCB-10

## Contact blocks

Description	Type	Order code	Pkg qty
<b>Single contact blocks for front mounting</b>			
1 NO	MCB-10	1SFA611610R1001	10
1 NC	MCB-01	1SFA611610R1010	10
1 NO with gold plated contacts	MCB-10G	1SFA611610R1101	10
1 NC with gold plated contacts	MCB-01G	1SFA611610R1110	10
<b>Double contact blocks for front mounting</b>			
2 NO	MCB-20	1SFA611610R1002	10
2 NC	MCB-02	1SFA611610R1020	10
<b>Single contact blocks for back mounting in enclosures</b>			
1 NO	MCB-10B	1SFA611610R2001	10
1 NC	MCB-01B	1SFA611610R2010	10



MCB-02



MCB-20

## Contact blocks with holder

Description	Type	Order code	Pkg qty
<b>Contact blocks with holder for front mounting, for non-illuminated operators</b>			
1 NO	MCBH-10	1SFA611605R1101	10
2 NO	MCBH-20	1SFA611605R1102	10
1 NC	MCBH-01	1SFA611605R1110	10
2 NC	MCBH-02	1SFA611605R1120	10
1 NO + 1 NC	MCBH-11	1SFA611605R1111	10



MCBH-11

# Modular range Assemblies



MLBL-01W

1SFC151252/0001



For more pilot devices products please see the complete catalog 1SFC151005C0201.

## LED blocks

Description	Rated current mA	Wavelength nm	Luminance mcd	Type	Order code	Pkg qty
<b>Rated voltage 24 V AC/DC</b>						
● Red	10.0	620	250	MLBL-01R	1SFA611621R1011	10
● Green	10.0	520	1500	MLBL-01G	1SFA611621R1012	10
● Yellow	10.0	588	250	MLBL-01Y	1SFA611621R1013	10
● Blue	10.0	468	450	MLBL-01L	1SFA611621R1014	10
○ White	10.0	600	600	MLBL-01W	1SFA611621R1015	10
<b>Rated voltage 110-130 V AC</b>						
● Red	10.0	620	200	MLBL-04R	1SFA611621R1041	10
● Green	10.0	520	1200	MLBL-04G	1SFA611621R1042	10
● Yellow	10.0	588	250	MLBL-04Y	1SFA611621R1043	10
○ White	10.0	<sup>1)</sup>	500	MLBL-04W	1SFA611621R1045	10
<b>Rated voltage 110-130 V DC</b>						
● Red	10.0	620	250	MLBL-05R	1SFA611621R1051	10
● Green	10.0	520	1500	MLBL-05G	1SFA611621R1052	10
● Yellow	10.0	588	300	MLBL-05Y	1SFA611621R1053	10
○ White	10.0	<sup>1)</sup>	600	MLBL-05W	1SFA611621R1055	10
<b>Rated voltage 230 V AC</b>						
● Red	10.0	620	250	MLBL-07R	1SFA611621R1071	10
● Green	10.0	520	1500	MLBL-07G	1SFA611621R1072	10
● Yellow	10.0	588	300	MLBL-07Y	1SFA611621R1073	10
● Blue	10.0	468	450	MLBL-07L	1SFA611621R1074	10
○ White	10.0	<sup>1)</sup>	600	MLBL-07W	1SFA611621R1075	10

Note: Care should be taken for DC supply where + and - must be correctly connected. This is marked X1 (+) and X2 (-) on the product.

<sup>1)</sup> X=0.31, Y=0.32 according to the ICI Chromaticity diagram.

## Accessories



KA1-8029  
KA1-8030

1SFC151258F0001



MA1-8015

1SFC151275/0001



KA1-8010

1SFC151379/0001



MA1-8053

1SFC151286F0001



MEPY1-0

1SFC151270/0001



MEP2-0

1SFC151272/0001

Description	Type	Order code	Pkg qty
<b>30 mm adaptors for 22 mm operator (1.5-4 mm panels)</b>			
<b>For pushbuttons, selector switches, pilot lights, potentiometers and buzzers</b>			
Black plastic	KA1-8029	1SFA616920R8029	1
Chrome metal	KA1-8030	1SFA616920R8030	1
<b>Mounting tool for operator</b>			
Mounting tool for tightening the locking nut	MA1-8015	1SFA611920R8015	1
<b>Protective cover</b>			
Protective cover	KA1-8010	1SFA616920R8010	10
<b>Note: For flush pushbutton to prevent accidental operation. Cannot be used together with Legend plate holder.</b>			
<b>Shroud for emergency stop</b>			
Yellow	MA1-8053	1SFA611920R8053	10
<b>Note: For 40 mm emergency stop pushbuttons. To prevent accidental operation. With anti rotation tabs and slot for pad-lock and with water drainage.</b>			
<b>Enclosures</b>			
1 seat - dark grey / light grey	MEP1-0	1SFA611811R1000	1
2 seats - dark grey / light grey	MEP2-0	1SFA611812R1000	1
3 seats - dark grey / light grey	MEP3-0	1SFA611813R1000	1
4 seats - dark grey / light grey	MEP4-0	1SFA611814R1000	1
6 seats - dark grey / light grey	MEP6-0	1SFA611816R1000	1
1 seat - yellow / light grey	MEPY1-0	1SFA611821R1000	1

# Modular range

## Technical data

### Standards and approvals

IEC / EN 60947-1	Low Voltage switchgear and controlgear - Part 1: General rules
IEC / EN 60947-5-1	Low Voltage switchgear and controlgear - part 5-1: control circuit devices and switching elements - electromechanical control circuit devices
IEC / EN 60947-5-5	Low Voltage switchgear and controlgear - part 5-5: control circuit devices and switching elements - electrical emergency stop device with mechanical latching function
IEC / EN 60073	Basic and safety principles for man-machine interface, marking and identification coding principles for indicators and actuators
IEC / EN 60529	Degrees of protection provided by enclosures (IP code)
EN 50013	Low Voltage switchgear and controlgear for industrial use - terminal marking and distinctive number for particular control switches
DIN 40050-9	Road vehicles; Degrees of protection (IP-code); protection against foreign objects; water and contact; electrical equipment
UL 508	Industrial control equipment
CSA C22.2 No 14	Industrial control equipment

### Environmental data

#### Degrees of protection

Operators	IEC/EN DIN	UL/CSA
Pushbutton: MP *	IP66	Type 1, 3R, 4, 4X, 12, 13
Double pushbutton: MPD	IP66	Type 1, 3R, 4, 4X, 12, 13
Mushroom pushbutton: MPM	IP66	Type 1, 3R, 4, 4X, 12, 13
Emergency stop: MPET/ MPEP MPMT/MPMP	IP66	Type 1, 3R, 4, 4X, 12, 13
Selector switch: M2SS/M3SS *	IP66	Type 1, 3R, 4, 4X, 12, 13
Key-operated selector switch: M2SSK/M3SSK *	IP66	Type 1, 3R, 4, 4X, 12
Toggle switch: MTS2/MTS3 *	IP66	Type 1, 3R, 4, 4X, 12, 13
Heavy duty pushbutton: KP6	-	Type 1, 3R, 4, 4X
Reset pushbutton: KPR *	IP 66	Type 1, 3R, 4, 4X, 12, 13
Joystick: MJS	IP66, 67, 69K	Type 1, 4X (indoor), 12, 13
Pilot lights: ML	IP66	Type 1, 3R, 4, 4X, 12, 13
Potentiometer: KT MT*	IP66	Type 1, 3R, 4, 4X, 12, 13
Contact block and LED block	IP20	-
Plastic enclosures	IP66	Type 1, 3R, 4, 4X, 12, 13
Metallic enclosures	IP66, 67, 69K	-

#### Temperature

Ambient temperature during operation	-25 to +70 °C
Storage temperature	-40 to +85 °C

\* With chrome plastic bezel IP66 Type 1, 12, 13

**Note: specified degree of protection is for operator mounted on panel. If other items are mounted in between, please make sure that they are correctly sealed.**

### Technical data

#### Terminals

Plus-minus pozidriv No.2 screw with DIN-washer.	
Connectable area	min. 1 x 0.5 mm <sup>2</sup> /AWG 20 max. 2 x 2.5 mm <sup>2</sup> /2 x AWG14

#### Tightening torque

Operators locking nut	Min. 2 Nm / Max. 2.3 Nm
Cable terminals	0.9 Nm

#### Material

No ozone depleting substances in the products. All front of panel plastic components are made of polycarbonate

PC polycarbonate	High impact strength, good outdoor resistance. Chemical resistance (see table below)
PSU polysulphone	Can withstand high temperatures, acids, basic solutions, alkaline compounds, oils, alcohols
PA polyamide	Can withstand high temperatures, aliphatic, aromatic and chlorinated hydrocarbons, esters, ketone-aldehydes, alcohols and basic solutions
PBT	Can withstand high temperature, aliphatic and aromatic hydrocarbons, acids, basic solutions, alcohols, grease and oils
Zinc	Good corrosion resistance in inland-, sea and industrial atmosphere
Light-alloy	Good corrosion resistance in inland-, sea and industrial atmosphere

#### Chemical resistance for polycarbonate

Chemical class	Effects
Acids	No significant effect under most typical conditions of concentration and temperature
Alcohols and alkalis	Generally compatible at low concentration and room temperature. Higher concentrations and elevated temperatures can result in etching and attack evidenced by decomposition
Aliphatic hydrocarbons	Generally compatible
Amines	Surface crystallization and chemical attack. Avoid
Aromatic hydrocarbons	Partial solvents and severe stress cracking agents (i.e., xylene, toluene). Avoid
Detergents and cleaners	Mild soap solutions are generally compatible. Strong alkaline materials should be avoided
Esters	Cause severe crystallization. Partial solvents. Avoid
Greases and oils	Pure petroleum types generally compatible. Many additives used with them are not
Halogenated, hydrocarbons	Solvents. Avoid
Ketones	Cause severe crystallization and stress cracking. Partial solvents. Avoid
Silicone oil and greases	Generally compatible up to 85 °C



# Modular range

## Technical data

### Electrical data

#### Standard contact blocks

Self cleaning silver contacts, NC contact with positive opening. At voltages and currents below 24 V and 5.6 mA we recommend our micro switch blocks.

#### Ratings as per IEC 60947-5-1

Rated insulation voltage, U <sub>i</sub>		690 V	
Rated thermal current, I <sub>t</sub>		10 A	
Rated operational current, I <sub>b</sub>	at: 120 V	8 A	
Utilization category AC 15,	at: 230 V	6 A	
	at: 400 V	4 A	
	at: 690 V	2 A	
Rated operational current, I <sub>b</sub> utilisation category DC 13,	at: 24 V	5 A	
	at: 125 V	1.1 A	
	at: 250 V	0.55 A	

#### Ratings as per UL, CSA, NEMA

		A600 AC		Q600 DC
Rated insulation voltage		600 V		600 V
Rated thermal current		10 A		2.5 A
Rated operational current	at: 120 V	6 A	at: 125 V	0.55 A
	at: 240 V	3 A	at: 250 V	0.27 A
	at: 480 V	1.5 A	at: 480 V	0.10 A
	at: 600 V	1.2 A	at: 600 V	0.10 A

#### Contact resistance

< 25 mΩ

#### Compulsory function test

at: 5V, 16 mA

#### Max. number of contact blocks per operator

The contact blocks can be stacked in max two levels on the 3-block holder. Only one level is accepted on the 5-block holder.

Pushbutton, toggle switch, mushroom pushbutton, double pushbutton, selector switch, key-operated selector switch and emergency stop operator 6

Joystick 8

#### Short circuit protection

Max. fuse at 1 kA gG 16A

Diagram for make and break contact



#### Micro switch block / Ratings as per IEC 60947-5-1







Rated insulation voltage, U <sub>i</sub>		125 V
Rated thermal current, I <sub>t</sub>		3 A
Rated operational current, I <sub>b</sub> utilisation category AC 14,	at: 125 V	0.5 A
Rated operational current, I <sub>b</sub> utilization category DC 13,	at: 24 V	0.3 A
Rated operational current, I <sub>b</sub> utilization category DC 12,	at: 24 V	0.1 A

#### Minimum switching capacity

Standard contact blocks	24 V DC	5.6 mA
Gold plated contact blocks	5 V DC	12 mA
	12 V DC	1 mA
Micro switch blocks	3 V DC	1 mA
Ratings as per UL 508	125 V AC	3 A
	60 V DC	0.2 A
	48 V DC	0.1 A

### Mechanical data

#### Mechanical life

Standard contact blocks		10 million operations
Pushbuttons, momentary mushroom pushbutton		2 million operations
Selector switches		
Present standard (no operation of center contact)		500 000 operations
		
With operation of center contact		250 000 operations
		150 000 operations
Maintained mushroom pushbutton, key-operated selector switch and double pushbutton		500 000 operations
Emergency stop		100 000 operations
Toggle switch		1 million operations
Joystick		500 000 operations
		400 000 operations
		300 000 operations

## Compact range Introduction

The compact range is our most efficient solution reducing both installation time and cost thanks to the all-in-one design. It is perfect for tough environment thanks to the market leading level of dust and water resistance.



High  
reliability

- IP66, IP67 and IP69K / Type 1, 3R, 4, 4X, 12, 13
- Wiping action to keep good connectivity even in tough environments



Easy to  
install

- All-in-one design for fast and easy installation
- Compact size with only 42 mm (1.65 in) depth

## Compact range Non-illuminated pushbuttons



Color	Contacts	Bezel	Type	Order code	Pkg qty
<b>Momentary flush pushbutton</b>					
● Red	1 NO	Black plastic	CP1-10R-10	1SFA619100R1011	10
● Red	1 NC	Black plastic	CP1-10R-01	1SFA619100R1041	10
● Red	1 NC	Chrome metal	CP1-30R-01	1SFA619100R3041	10
● Red	1 NO +1 NC	Black plastic	CP1-10R-11	1SFA619100R1071	10
● Green	1 NO	Black plastic	CP1-10G-10	1SFA619100R1012	10
● Green	1 NO	Chrome metal	CP1-30G-10	1SFA619100R3012	10
● Green	2 NO	Black plastic	CP1-10G-20	1SFA619100R1022	10
● Green	1 NO +1 NC	Black plastic	CP1-10G-11	1SFA619100R1072	10
● Yellow	1 NO	Black plastic	CP1-10Y-10	1SFA619100R1013	10
● Yellow	1 NO +1 NC	Black plastic	CP1-10Y-11	1SFA619100R1073	10
● Blue	1 NO	Black plastic	CP1-10L-10	1SFA619100R1014	10
○ White	1 NO	Black plastic	CP1-10W-10	1SFA619100R1015	10
● Black	1 NO	Black plastic	CP1-10B-10	1SFA619100R1016	10
● Black	2 NO	Black plastic	CP1-10B-20	1SFA619100R1026	10
● Black	1 NO +1 NC	Black plastic	CP1-10B-11	1SFA619100R1076	10

## Illuminated pushbuttons



Color	Contacts	Bezel	Type	Order code	Pkg qty
<b>Flush momentary pushbutton</b>					
<b>Rated voltage 24 V AC/DC</b>					
● Red	1 NO	Black plastic	CP1-11R-10	1SFA619100R1111	10
● Red	1 NC	Black plastic	CP1-11R-01	1SFA619100R1141	10
● Green	1 NO	Black plastic	CP1-11G-10	1SFA619100R1112	10
<b>Rated voltage 110-130 V AC/DC</b>					
● Red	1 NO	Black plastic	CP1-12R-10	1SFA619100R1211	10
● Red	1 NC	Black plastic	CP1-12R-01	1SFA619100R1241	10
● Green	1 NO	Black plastic	CP1-12G-10	1SFA619100R1212	10
<b>Rated voltage 220 V AC/DC</b>					
● Red	1 NO	Black plastic	CP1-13R-10	1SFA619100R1311	10
● Red	1 NC	Black plastic	CP1-13R-01	1SFA619100R1341	10
● Green	1 NO	Black plastic	CP1-13G-10	1SFA619100R1312	10



For more pilot devices products  
please see the complete catalog  
1SFC151005C0201.

# Compact range Heavy duty pushbuttons



CP6-10R-11

1SFC151023W001



CP6-10G-11

1SFC151024W001



CP6-10B-11

1SFC151023W001

Color	Contacts	Type	Order code	Pkg qty
<b>Heavy duty pushbutton</b>				
● Red	1NO+1NO	CP6-10R-11	1SFA619105R1071	10
● Green	1NO+1NO	CP6-10G-11	1SFA619105R1072	10
● Black	1NO+1NO	CP6-10B-11	1SFA619105R1076	10



For more pilot devices products  
please see the complete catalog  
1SFC151005C0201.

# Non-illuminated emergency stop pushbuttons



CE3T-10R-01

1SFC151161W001



CE4P-10R-02

1SFC151163W001



CE4T-10R-01

1SFC151164W001



CE4K1-10R-02

1SFC151166W001

Description	Type	Order code	Pkg qty
<b>Ø 30 mm</b>			
<b>Twist release</b>			
1 NC	CE3T-10R-01	1SFA619500R1041	1
2 NC	CE3T-10R-02	1SFA619500R1051	1
1 NO + 1 NC	CE3T-10R-11	1SFA619500R1071	1
<b>Ø 40 mm</b>			
<b>Twist release</b>			
1 NC	CE4T-10R-01	1SFA619550R1041	1
2 NC	CE4T-10R-02	1SFA619550R1051	1
1 NO + NC	CE4T-10R-11	1SFA619550R1071	1
<b>Pull release</b>			
2 NC	CE4P-10R-02	1SFA619551R1051	1
1 NO + 1 NC	CE4P-10R-11	1SFA619551R1071	1
<b>Key release, ronis 455, key code 71</b>			
2 NC	CE4K1-10R-02	1SFA619552R1051	1
1 NO + 1 NC	CE4K1-10R-11	1SFA619552R1071	1

# Compact range Pilot lights



CL2-502R

1SFC151038/0001



CL2-502G

1SFC151039/0001



CL2-502Y

1SFC151040/0001



CL2-502L

1SFC151041/0001



CL2-502C

1SFC151042/0001

Color	Rated current mA	Anti-inductive Voltage (Vpeak)	Wavelength nm	Illumination lx	Type	Order code	Pkg qty
<b>Rated voltage 24 V AC/DC</b>							
● Red	16	6	625	80	CL2-502R	1SFA619403R5021	10
● Green	16	6	520	135	CL2-502G	1SFA619403R5022	10
● Yellow	16	6	590	55	CL2-502Y	1SFA619403R5023	10
● Blue	16	6	470	10	CL2-502L	1SFA619403R5024	10
○ Clear	16	6	(X=0.31,Y=0.32)	230	CL2-502C	1SFA619403R5028	10
<b>Rated voltage 110-130 V AC</b>							
● Red	15-17	20	625	85	CL2-513R	1SFA619403R5131	10
● Green	15-17	20	520	90	CL2-513G	1SFA619403R5132	10
● Yellow	15-17	20	590	85	CL2-513Y	1SFA619403R5133	10
<b>Rated voltage 110-130 V DC</b>							
● Red	8-9	20	625	55	CL2-515R	1SFA619403R5151	10
● Green	8-9	20	520	125	CL2-515G	1SFA619403R5152	10
● Yellow	8-9	20	590	50	CL2-515Y	1SFA619403R5153	10
<b>Rated voltage 220 V DC</b>							
● Red	6	20	625	40	CL2-520R	1SFA619403R5201	10
● Green	6	20	520	90	CL2-520G	1SFA619403R5202	10
● Yellow	6	20	590	30	CL2-520Y	1SFA619403R5203	10
<b>Rated voltage 230 V AC</b>							
● Red	17	30	625	95	CL2-523R	1SFA619403R5231	10
● Green	17	35	520	155	CL2-523G	1SFA619403R5232	10
● Yellow	17	35	590	70	CL2-523Y	1SFA619403R5233	10
● Blue	17	35	470	10	CL2-523L	1SFA619403R5234	10
○ Clear	17	35	(X=0.31,Y=0.32)	225	CL2-523C	1SFA619403R5238	10
<b>Rated voltage 380-415 V AC</b>							
● Red	15-17	55	625	85	CL2-524R	1SFA619403R5421	10
● Green	15-17	65	520	130	CL2-524G	1SFA619403R5422	10

# Buzzers



CB1-610R

1SFC151159/0001



CB1-620B

1SFC151160/0001

Color	Lights and sound output	Rated current mA	Luminance mcd	Type	Order Code	Pkg qty
<b>Illuminated</b>						
<b>Rated voltage 24 V AC/DC</b>						
● Red	Pulsation	53	60	CB1-610R	1SFA619600R6101	10
<b>Rated voltage 110-130 V AC</b>						
● Red	Pulsation	70	60	CB1-611R	1SFA619600R6111	10
<b>Rated voltage 110-130 V DC</b>						
● Red	Pulsation	15	60	CB1-612R	1SFA619600R6121	10
<b>Rated voltage 230 V AC</b>						
● Red	Pulsation	70	60	CB1-613R	1SFA619600R6131	10
<b>Non-illuminated</b>						
<b>Rated voltage 24 V AC/DC</b>						
● Black	Continuous	40	-	CB1-620B	1SFA619600R6206	10
● Black	Pulsation	48	-	CB1-630B	1SFA619600R6306	10
<b>Rated voltage 110-130 V AC</b>						
● Black	Continuous	40	-	CB1-621B	1SFA619600R6216	10
● Black	Pulsation	48	-	CB1-631B	1SFA619600R6316	10
<b>Rated voltage 110-130 V DC</b>						
● Black	Continuous	15	-	CB1-622B	1SFA619600R6226	10
● Black	Pulsation	15	-	CB1-632B	1SFA619600R6326	10
<b>Rated voltage 230 V AC</b>						
● Black	Continuous	40	-	CB1-623B	1SFA619600R6236	10
● Black	Pulsation	40	-	CB1-633B	1SFA619600R6336	10

# Compact range Non-illuminated selector switches



C2SS1-10B-10

1SFC151259V0001



C3SS1-30B-20

Description	Contacts	Bezel	Type	Order code	Pkg qty
<b>2-position, short handle</b>					
	1 NO	Black plastic	C2SS1-10B-10	1SFA619200R1016	10
	2 NO	Black plastic	C2SS1-10B-20	1SFA619200R1026	10
	1 NO +1 NC	Black plastic	C2SS1-10B-11	1SFA619200R1076	10
	1 NO	Black plastic	C2SS2-10B-10	1SFA619201R1016	10
	2 NO	Black plastic	C2SS2-10B-20	1SFA619201R1026	10
	1 NO +1 NC	Black plastic	C2SS2-10B-11	1SFA619201R1076	10
<b>3-position, short handle</b>					
	2 NO	Black plastic	C3SS1-10B-20	1SFA619210R1026	10
	2 NO	Chrome metal	C3SS1-30B-20	1SFA619210R3026	10
	1 NO +1 NC	Black plastic	C3SS1-10B-11	1SFA619210R1076	10
	2 NO	Black plastic	C3SS2-10B-20	1SFA619211R1026	10

# Compact range Accessories



KA1-8010

1SFC151379F0001



KA1-8021

1SFC151512W0001



MA1-8130

1SFC151488R0001



KA1-8029  
KA1-8030

1SFC151263F0001



KA1-8120  
KA1-8121

1SFC151386F0001



CA1-1026

1SFC151269V0001



CEPY1-0

1SFC151285V0001



CA1-8053

1SFC151286V0001

Description	Type	Order code	Pkg qty
<b>Protective cover</b>			
Protective cover	KA1-8010	1SFA616920R8010	10
Note: For flush pushbutton to prevent accidental operation. Cannot be used together with Legend plate holder.			
<b>Bezel</b>			
<b>For pushbuttons</b>			
Chrome metal	KA1-8021	1SFA616920R8021	10
<b>Blanking plug</b>			
Black	MA1-8130	1SFA611920R8130	10
<b>Adaptors 30 mm</b>			
Black plastic	KA1-8029	1SFA616920R8029	1
Metal	KA1-8030	1SFA616920R8030	1
Note: For use when fitting the 22 mm pilot devices in 30 mm mounting holes (1.5 - 4 mm panels) For use with pushbuttons, selector switches, emergency stop pushbutton and pilot lights			
<b>Legend plates and holders</b>			
Grey legend plate holder for plastic enclosures	MA6-1060	1SFA611930R1060	1
Black legend plate holder	KA1-8120	1SFA616920R8120	1
Legend plate without text or symbol	KA1-8121	1SFA616920R8121	1
Legend plate for emergency stops for compact enclosures	CA6-1026	1SFA619930R1026	1
<b>Enclosures</b>			
Yellow compact enclosure for emergency stop pushbuttons	CEPY1-0	1SFA619821R1000	1
Yellow shroud	CA1-8053	1SFA619920R8053	1
Distance washer		SK615516-1	1



For more pilot devices products please see the complete catalog 1SFC151005C0201.

# Compact range

## Technical data

### Standards and Approvals

IEC / EN 60947-1	Low Voltage switchgear and controlgear - Part 1: General rules
IEC / EN 60947-5-1	Low Voltage switchgear and controlgear - Part 5-1: Control circuit devices and switching elements - Electromechanical control circuit devices
IEC / EN 60947-5-5	Low Voltage switchgear and controlgear - Part 5-5: Control circuit devices and switching elements - Electrical emergency stop device with mechanical latching function
IEC / EN 60073	Basic and safety principles for man-machine interface, marking and identification, coding principles for indicators and actuators
IEC / EN 60529	Degrees of protection provided by enclosures (IP code)
EN 50013	Low Voltage switchgear and controlgear for industrial use, terminal marking and distinctive number for particular control switches
DIN 40050-9	Road vehicles; degrees of protection (IP-code); protection against foreign objects; water and contact; electrical equipment
UL 508	Industrial control equipment
CSA C22.2 No 14	Industrial control equipment

### Environmental data

#### Degrees of protection

Pilot device:	IEC/EN DIN	UL/CSA
Pushbuttons	IP66, IP67 and IP69K	Type 1, 3R, 4, 4X, 12, 13
Selector switches	IP66, IP67 and IP69K	Type 1, 3R, 4, 4X, 12, 13
Buzzer	IP66, IP67 and IP69K	Type 1, 3R, 4, 4X, 12, 13
Heavy duty	IP66, IP67 and IP69K	Type 1, 3R, 4, 4X, 12, 13
Pilot lights	IP66, IP67 and IP69K	Type 1, 3R, 4, 4X, 12, 13
Emergency stops	IP66, IP67 and IP69K	Type 1, 3R, 4, 4X, 12, 13
Terminals	IP20	

#### Temperature

Ambient temperature during operation	-25 to +70 °C
Storage temperature	-40 to +85 °C

### Technical data

#### Cable connections

Operator	Cable terminal
Pushbutton	Plus-minus Pozidriv No. 2
Selector switch	Connectable area: min. 1 x 0.5 mm <sup>2</sup> / 1 x AWG22 max. 2 x 1.5 mm <sup>2</sup> / 2 x AWG14
Emergency stop	
Pilot light	Connectable area: min. 1 x 0.5 mm <sup>2</sup> / 1 x AWG20 max. 2 x 2.5 mm <sup>2</sup> / 2 x AWG14

#### Tightening torque

Operators locking nut	Min. 2 Nm / Max. 2.3 Nm
Cable terminals M3	0.8 Nm
Cable terminals M3.5	0.9 Nm

#### Short circuit protection

Max. fuse at 1 kA	gG 10A
-------------------	--------

#### Mechanical life

Pushbuttons, selector switches, heavy duty	500 000 operations
Emergency stop pushbutton	50 000 operations

### LED

Service life	≥ 50 000 h, operating at 25°C, 40~70%rh
Voltage tolerance	-30 to +10 % voltage is acceptable without affecting the service life

### Make-and-break contacts

Pushbutton	Emergency stop pushbutton

### Material

No ozone depleting substances in the products.	
All front of panel plastic components are made of polycarbonate	
PC polycarbonate	High impact strength, good outdoor resistance. Chemical resistance (see table below)
PSU polysulphone	Can withstand high temperatures, acids, basic solutions, alkaline compounds, oils, alcohols
PA polyamide	Can withstand high temperatures, aliphatic, aromatic and chlorinated hydrocarbons, esters, ketone-aldehydes, alcohols and basic solutions
PBT	Can withstand high temperature, aliphatic and aromatic hydrocarbons, acids, basic solutions, alcohols, grease and oils
Zinc	Good corrosion resistance in inland-, sea and industrial atmosphere
Light-alloy	Good corrosion resistance in inland-, sea and industrial atmosphere

### Chemical resistance for polycarbonate

Chemical class	Effects
Acids	No significant effect under most typical conditions of concentration and temperature
Alcohols and alkalis	Generally compatible at low concentration and room temperature. Higher concentrations and elevated temperatures can result in etching and attack evidenced by decomposition
Aliphatic hydrocarbons	Generally compatible
Amines	Surface crystallization and chemical attack. Avoid
Aromatic hydrocarbons	Partial solvents and severe stress cracking agents (i.e., xylene, toluene). Avoid
Detergents and cleaners	Mild soap solutions are generally compatible. Strong alkaline materials should be avoided
Esters	Cause severe crystallization. Partial solvents. Avoid
Greases and oils	Pure petroleum types generally compatible. Many additives used with them are not
Halogenated, hydrocarbons	Solvents. Avoid.
Ketones	Cause severe crystallization and stress cracking. Partial solvents. Avoid
Silicone oil and greases	Generally compatible up to 85 °C

**Note: Specified degree of protection is for operator mounted on panel. If other items are mounted in between, please make sure that they are correctly sealed.**

### Electrical data

#### Contacts

##### Ratings as per IEC 60947-5-1

Rated insulation voltage, U <sub>i</sub>		300 V
Rated thermal current, I <sub>t</sub>		5 A
Rated operational current, I <sub>o</sub>		
Utilization category AC-15	at: 240 V	1 A
Rated operational current, I <sub>o</sub>	at: 24 V	0.3 A
Utilization category DC-13	at: 125 V	0.2 A

##### Ratings as per UL, CSA, NEMA

	C300 AC	R300 DC
Rated insulation voltage	250 V	250 V
Rated thermal current	2.5 A	1 A
Rated operational current		
	at: 120 V	1.5 A
	at: 125 V	
	at: 240 V	0.75 A
	at: 250 V	0.11 A

#### Short circuit protection

Max. fuse at 1 kA	gG 10A
-------------------	--------

#### Buzzer

Max. fuse at 1 kA	gG 10A
-------------------	--------

##### Ratings as per IEC 60947-5-1

Rated insulation voltage, U <sub>i</sub>	300 v
Rated impulse withstand voltage u <sub>imp</sub>	4kV
Rated frequency	50-60 Hz
Sound level db	≥90 db / 10 cm
Product service life	>5000 hours

# Contact us

ABB AB  
Electrification Products  
SE-721 61 VÄSTERÅS, Sweden

<http://new.abb.com/low-voltage/products/pilot-devices>

Note: We reserve the right to make technical changes or modify the contents of this document without prior notice. With regard to purchase orders, the agreed particulars shall prevail. ABB AG does not accept any responsibility whatsoever for potential errors or possible lack of information in this document.

We reserve all rights in this document and in the subject matter and illustrations contained therein. Any reproduction, disclosure to third parties or utilization of its contents – in whole or in parts – is forbidden without prior written consent of ABB AG.

Copyright © 2016 ABB  
All rights reserved

