

QUASAR SCIENCE

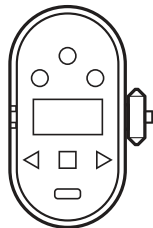
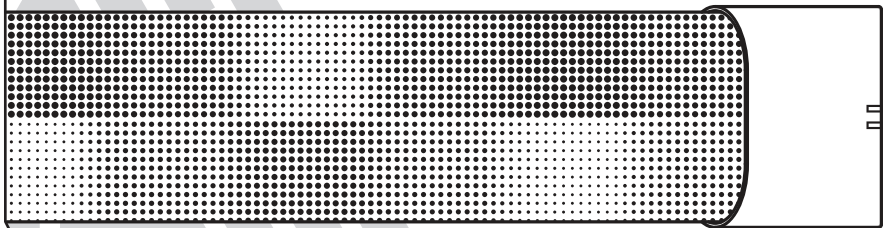

RR
LED Linear Light

Quick Start Guide

What's in the Box

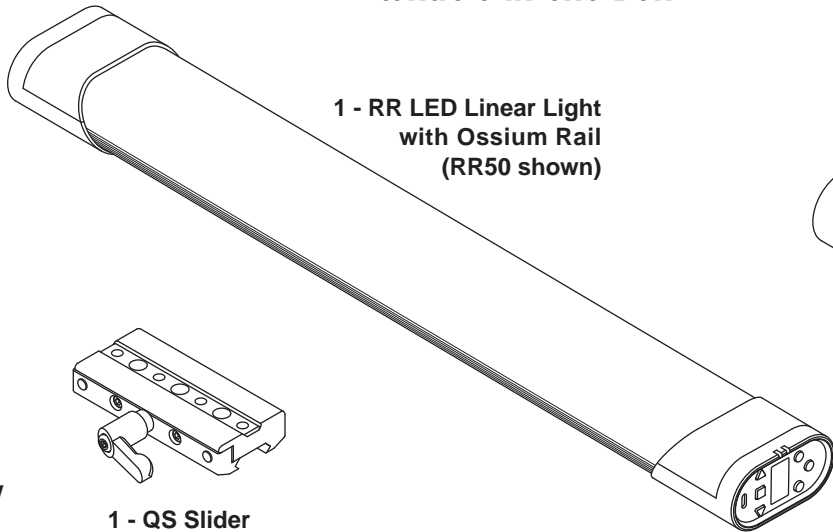

1 - RR LED Linear Light
with Ossium Rail
(RR50 shown)

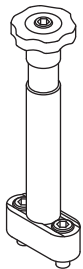

1 - QS Dual Screw
Baby Pin

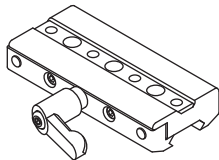

1 - QS Slider

2 - Silicon Bumpers

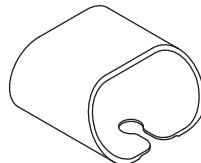
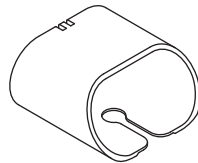

1 - 8ft AC Power Cable

1 - 8ft DC Power Cable:
P-TAP to 2.1mm Barrel

1 - Quick Start Guide

1 - Short Cut Guide

RR Overview

*RR50 shown as reference

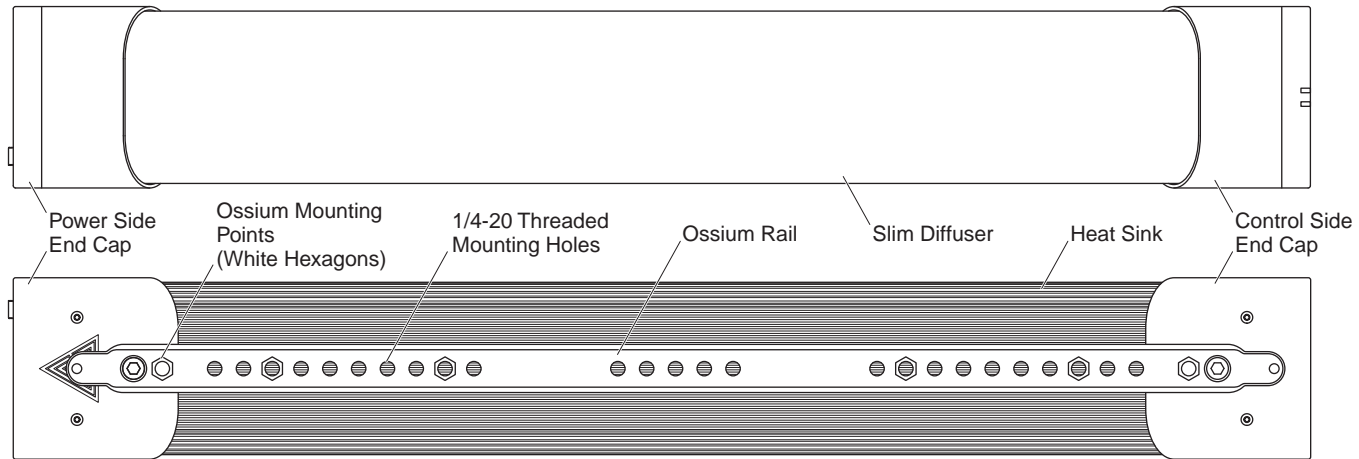

RR Interface Layout

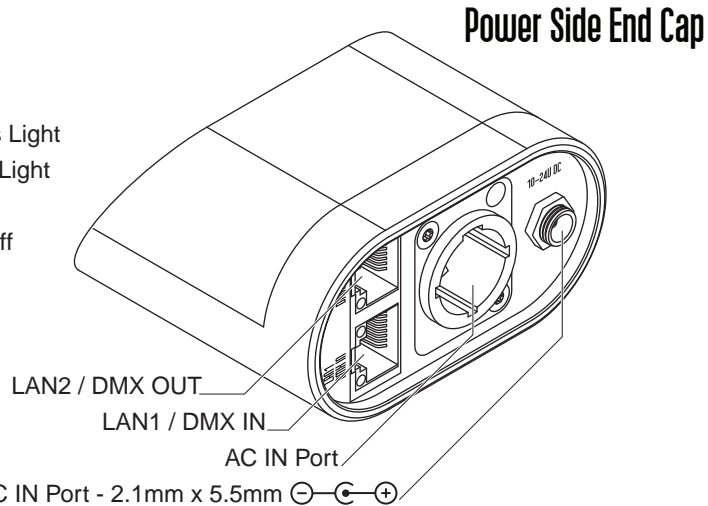
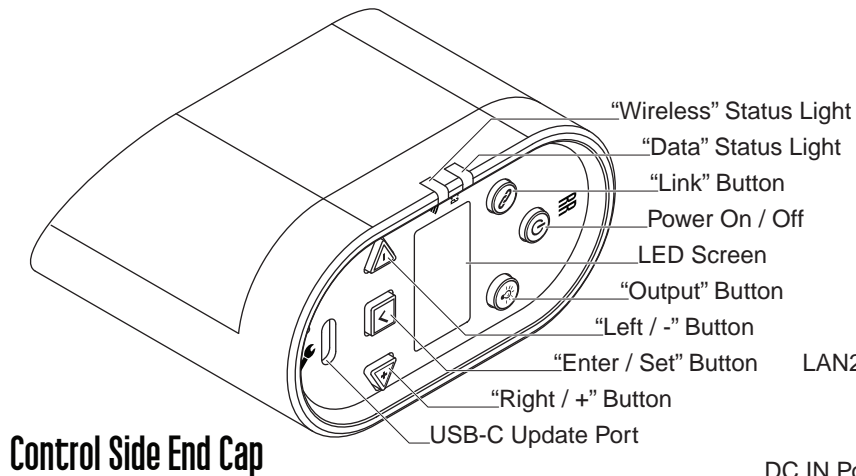

Mounting RR

**Mount Dual Screw Baby Pin
directly to lamp**

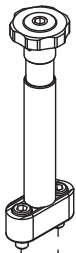

**Mount Dual Screw Baby Pin
to Ossium Rail Slider for added
convenience and versatility**

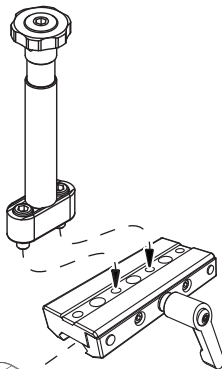

**Mount Rotator Block
directly to lamp**

*Rotator Blocks sold separately



**Mount Rotator Block
to Ossium Rail Slider for added
convenience and versatility**

*Rotator Blocks sold separately

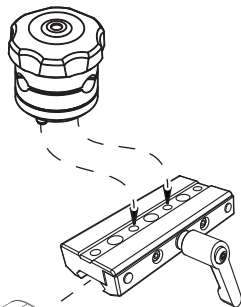

Getting Started

- To set the **Intensity, Color Temp, +/- Green, Saturation** and **Hue**:

1. Press or until desired function is shown on screen, and press to select.
2. The selection carets "> <" will move from the ">**Function**<" to the ">**Value**<".
3. Press or to set the value. Press to save.
4. The selection carets "> <" will move from the ">**Value**<" back to the ">**Function**<".







- To link an RR or R2 lamp to a CRMX /Wireless DMX transmitter:

1. Double tap . Go to **Wireless Mode->Wireless DMX**.
2. If the "**Wireless**" **Status Light** is flashing, press and hold to unpair.
3. On the DMX transmitter, tap the link button to pair.
4. The "**Wireless**" **Status Light** will start to flash and turn solid Green once paired.

- When connected wirelessly to a DMX transmitter or **Lead Lamp**, the Wireless signal strength will be shown as vertical bars.





Key Interface

-  **Power Button:** Lamp on: Press and hold for 1 second. Lamp Off: Press and hold for 2 seconds.
-  **Output Button:** Toggle the button to enable/disable lamp output for manual mode operation. Change the color/intensity without the change affecting the environment.
-  **Link Button:** Press and hold to unlink lamp. Double Tap to bring up Wireless Menu (Pg 13.)
-  **Left / Minus Button:** Decrease a value or navigate Left.
-  **Right / Plus Button:** Increase a value or navigate Right.
-  **Enter / Save Button:** Enter selection, Save Value.
-  **Upgrade Port:** USB-C Port for performing software updates with a USB-C Thumb Drive.











Status Lights

The **Data** and **Wireless Status Lights** can be various colors based on the connection type and status. Check that the lamp is in the correct wired and wireless modes and that Status lights are enabled in the config. See Page 8 for color combinations.

Data LED











-  **Data** Solid LED – Data Received.
-  **Data** No Light – No Data Received or Status Lights turned off.

Wireless LED

-   Solid LED – Connected to Wireless Device.
-    Slow Flashing – Lamp is paired with Wireless Device, but device is not found.
-    Fast Flashing – Lamp is connecting to Wireless Device.
-   No Light – Lamp is Not Paired with Wireless Device, Wireless Mode -> Off or Status Lights turned off.

*Check the website for the most up-to-date Status Light information.



Status Lights

- | | | | |
|---|--|---|--|
| ● Data | Manual Mode | ● Data | Wireless DMX |
| ●  | Data: Off / Wireless: Off | ●  | Data:Red / Wireless: Green (Or Universe Color) |
| ● Data | DMX Mode / Data Received | ● Data | Wifi Mode (Art-net over Wifi) |
| ●  | Data: Red / Wireless: Off | ●  | Data: Yellow / Wireless: Magenta |
| ● Data | Ethernet Mode / Data Received | ● Data | Bluetooth Mode |
| ●  | Data: Yellow / Wireless: Off | ●  | Data: Blue / Wireless: Blue |
| ● Data | Wired Leader (Lead/Follow Mode) | ● Data | Wireless Leader (Lead/Follow Mode) |
| ●  | Data: Green / Wireless: Off | ●  | Data: Green / Wireless: Purple |
| ● Data | Wired Follower (Lead/Follow Mode) | ● Data | Wireless Follower (Lead/Follow Mode) |
| ●  | Data: Cyan / Wireless: Off | ●  | Data: Cyan / Wireless: Purple |

*Check Status Lights are enabled in Config



Button Shortcuts



Min / Max Value Jump: On parameter menus such as Intensity, Color Temperature, Saturation, Hue, and Effects Parameters.



While pressing and holding  to increase the value, tapping  will jump to the next value or max value.

While pressing and holding  to decrease the value, tapping  will jump to the next value or minimum value.

Enable/Disable Status Lights: Press and hold  for 5 seconds to disable the status lights. Press again for 5 seconds to enable.

Enable/Disable RDM: Press and hold   for 2 seconds to disable RDM. Press again for 2 seconds to enable.

Enable/Disable Wireless: Press and hold   for 2 seconds to disable all Wireless Functions. Press again for 2 seconds to enable.

Reset to Default: Press and hold   for 3 seconds to reset the lamp to Default settings.

Link Button: Press and hold  to unpair a lamp.

Wireless Menu: Double press  to open the Wireless Menu.

Main Menu - Manual Mode

- > **Intensity** 0 to 100% in 1% increments
- > **Color Temp** 1750K to 10,000K
- > **+/- Green** 100M to 0G to 100G
- > **Saturation** 0 to 100% by 1% increments
- > **Hue** 0° to 360°
- > **CT Preset** 3200K - 4000K - 5000K - 5600K - 6000K - 2000K - 2800K
- > **Color Preset** Red - Orange - Yellow - Green - Cyan - Blue - Violet - Magenta
- > **Effects** Rainbow - Short Circuit - Paparazzi - Strobe - Fire - Emergency Lights - TV - Demo* **(See Page 17-18)**
- > **Config** Lamp Settings **(See Page 11)**

*Check the website for newly added effects

Config Menu

- > **DMX Channel** Set the DMX Channel.
- > **Number of Pixels** Control the light as groups. **(See Page 12)**
- > **Profile** Set the DMX profile for the light. **(See Page 18-23)**
- > **Wired Settings** Select the Wired data options to control the light. (DMX, Art-Net, sACN) **(See Page 13)**
- > **Wireless Settings** Select the Wireless data options. (CRMX, Bluetooth, Wifi) **(See Page 14)**
- > **Lead / Follow** Set Lead/Follow mode for the light. **(See Page 15)**
- > **Output Mode** Set the lamp to Normal Output, High Output, or Low Output Mode. **(See Page 16)**
- > **Rig Mode** When Enabled, turns on when it is powered. When disabled, requires power button pressed. **(See Page 16)**
- > **Status Lights** Turns the status lights on/off for use on camera.
- > **Languages** English (Check the website for additional languages.)
- > **Lamp Hours** Displays the total hours the lamp has been powered on. Press Enter to See LED Hours.
- > **Update Firmware** Set the lamp into Update mode.
- > **Firmware** Displays the firmware version on the lamp.
- > **Reset to Default** Sets the lamp back to all its default values.

Pixel Selection

- > **Number of Pixels** 1, 2, 5, 10, 20 - These are the available grouping options for the RR50's 20 individually controllable pixels.
1, 2, 3, 4, 6, 8, 12, 16, 24, 48 - These are the available grouping options for the RR100's 48 individually controllable pixels.
- When choosing DMX profiles, each group of parameters are repeated per pixel except for the **FX Parameters**.
 - When a RR100 is set to 1 Pixel for an example, it will control the entire lamp as 1 pixel and require 1 set of DMX Data to control it, plus additional channels required for **FX Parameters**.
 - When a RR100 is set to 48 Pixels for an example, it will control the lamp as 48 pixels and require 48 sets of DMX Data to control it, plus additional channels required for **FX Parameters**.

Wired Control Menu

> **Wired Mode**

> **DMX**

> **Ethernet**

> **DMX Settings**

> **DMX Channel**

> **Terminate**

> **Ethernet Settings**

> **View IP Address**

> **IP Address Mode**

> **DHCP (Auto)**

> **Static**

> **IP Address, Subnet Mask, Gateway**

> **Universe**

> **DMX Channel**

> **Ethernet Mode**

Choose DMX512 or Ethernet Mode to Wire Control the light.

Control the lamp with DMX512.

Control the lamp with sACN or Art-Net.

Set the DMX Channel 001 to 508 (Does not allow address to be outside of 512).

Terminate the DMX Signal when last in line.

Show the IP address automatically received through DHCP or the Static IP address set.

Set the IP Address Mode.

Allow the lamp to obtain the IP address from the router automatically.

Allow the lamp to set the IP address manually.

Enter the IP address, Subnet mask, and Gateway.

Set the Universe for the lamp.

Set the DMX Channel 001 to 508 (Does not allow address to be outside of 512).

Choose the Ethernet protocol: sACN/Art-Net, sACN Only, Art-Net Only.

Wireless Control Menu

> Wireless Mode

> Wireless DMX

Lumen Radio CRMX wireless DMX. Press and hold  to Clear. Tap transmitter to pair.

> Bluetooth

Connect to the lamp over Bluetooth.

> Wifi

Connect to a wireless network to receive Art-Net over Wifi.

> Off

Turns off all Wireless functionality.

> Wireless DMX Settings*

Shows the Hardware and Firmware of the CRMX TimoTwo.

> Wifi Settings*

Turns the lamp into a wireless access point to allow mobile device to set up wireless settings.

> Bluetooth Settings

>Reset

Reset Bluetooth connection.

> Status Lights On/Off

Turns off status lights for use when lamp is seen on camera.

> Reset Wireless Settings to Default

Reset All Wireless Settings to factory default.



Tip: Double Tap  to bring up the Wireless Control menu.

*See the full Manual for Detailed Descriptions of the Wireless DMX Settings and Wifi Settings.

Lead/Follow Mode

- **Lead/Follow** mode allows one lamp to control many lamps at once. The **Lead** transmits DMX data wired or wirelessly to the **Follows**. When the **Lead** changes levels, the **Follows** will change as well. This applies to on board FX as well.
- To use **Lead/Follow** mode, go to **Config -> Lead/Follow**. Set the leader to **Lead** and set all of the followers to **Follow 1** to match the leader. **Follow 2-8** are used with effects to do the same effect with different timings. This will run the same effects, intensities and levels but not in sync.



- To use **Lead/Follow** wired, plug a Cat5 cable into the **DMX OUT** port of the leader into the In of the followers. Repeat out of the followers and into the next. The **Data** light should be illuminated on all the followers.
- To use **Lead/Follow** wirelessly, on the followers, press and hold  to unpair the lamp. Next tap  on the leader. On all of the followers, the **Wireless** signal light should begin flashing and then remain solid.

Output Mode

- There are 3 different **Output Modes**, which are used to increase the light output or the resolution in different areas of the dimming range.

> **Output Mode**

Normal Output: Normal Operating Temperature, standard lamp output.

High Output: High Operating Temperature, maximum output.

Low Output: Gives maximum resolution in the low dimming section of the lamp. Maximum power is about 25% of High Output.

Rig Mode

- Rig mode is used to define how you want to turn on the lamp. When Rig Mode is enabled, the lamp will turn on when it is powered. This mode is preferred when the light is rigged on a spot that is remote or difficult to reach.

- When Rig mode is disabled, after being powered connecting power, the Power button must be pressed. This is recommended for normal operation.

Effects (Manual)

Main Menu

Effect	Result
Rainbow	Scroll through the hue from 0° at full saturation
Short Circuit	Lamp is on with random bursts of turning off
Paparazzi	Lamp is off with random flashes of turning on
Strobe	Rhythmic flashes on
Fire	A fire flicker effect
Emergency Lights	Flashing lights of various colors
Demo	Scroll through the hue from 0° at 0%, 25%, 50%, 75% and 100% saturation at 2000k and 6000k

Effects Parameters

Item	Result
Effect	Choose effect
Intensity	Set Intensity of effect
Color Temp	Set base color temp
+/- Green	Set +/- green of the color temp
Saturation	Saturate the effect
Hue	Set the hue
Rate	0-200% for the speed of the effect 100% is normal speed

***Check the website for newly added effects.

Effect Controls (Manual)

Fire Submenu

Weight	Result
Rate	0-200% for the speed of the effect 100% is normal speed
Maximum	Highest intensity level of effect
Minimum	Lowest intensity level of effect
Weight	Low, Centered, High
Preset	+/-400k Color at 2400k, 3200k, 4000k, 5600k

Emergency Light Submenu

Item	Result
Pattern	Single, Double, Triple, Quad
Color Presets	R&B, B&B, R&32, R&56, B&32, B&56 R&B&32, R&B&56
Color 1 & 2	Red, Orange, Yellow, Green, Blue, Magenta, 2000k, 3200k, 4000k, 5600k, 6000k

TJ Submenu

Item	Result
Color Presets	Blues & Whites, Blues and Warm

DMX Profiles (Overview)

DMX Profiles (Basic)	Profiles 1 - 8 Profiles 13, 14	Different DMX channel arrangements to control the Parameters for your lamps. Direct control of the 5 available colors channels; Red, Green, Blue, 2000K, 6000K
DMX Profiles (FX)	Profiles 9 - 12	Control the basic parameters of the lamp and allow control of the built-in effects of the lamp.
DMX Profiles (Extended FX)	Profiles 15 - 18	Control the basic parameters of the lamp and built in effects with added channels to allow the effects made of two colors have additional parameters.

*When using the lamp in multipixel modes, the color parameters are repeated for each pixel.
For FX Profiles, while the color parameters are repeated for each pixel, the effect parameters are per fixture.

*An example of patching as multiple pixels: when patching as 2 pixels in Profile 9 (HSIC+FX), it would be 5 channels per pixel plus 3 FX Channels, for a total of 13 Channels.

DMX Profiles (Basic)

When using as more than one pixel, 1 additional channel group must be added per additional pixel.

#	Name	Bit Depth	# of Channels Per Pixel	Channel Description
1	HSIC	8 Bit	5	1: Intensity 2: Color Temp 3: +/- Green Control 4: Hue 5: Saturation
2	HSIC-16	16 Bit	8	1+2: Intensity 3+4: Color Temp 5: +/- Green Control 6+7: Hue 8: Saturation
3	HSI	8 Bit	3	1: Intensity 2: Hue 3: Saturation
4	XFade with +/-G	8 Bit	3	1: Intensity 2: Color Temp 3: +/- Green Control
5	XFade	8 Bit	2	1: Intensity 2: Color Temp
6	CCT & RGB	8 Bit	7	1: Intensity 2: Color Temp 3: +/- Green Control 4: Crossfade 5: Red 6: Green 7: Blue
7	CCT & RGB-16	16 Bit	9	1+2: Intensity 3: Color Temp 4: +/- Green Control 5+6: Crossfade 7: Red 8: Green 9: Blue
8	RGB	8 Bit	3	1: Red 2: Green 3: Blue
13	RGBTD	8 Bit	5	1: Red 2: Green 3: Blue 4:2000K 5: 6000K
14	RGBTD	16 Bit	10	1+2: Red 3+4: Green 5+6: Blue 7+8:2000K 9+10: 6000K

DMX Profiles (Basic) Parameters

Available Parameters based on Profile

Parameter	DMX Value	Value
Intensity	0-255	0 - 100%
Color Temp	0-255	2000K-6000K
+/- Green		See Chart at right
Hue	0-255	0° - 360°
Saturation	0-255	0 - 100%
Crossfade	0-255	0 - 100%
Red	0-255	0 - 100%
Green	0-255	0 - 100%
Blue	0-255	0 - 100%

+/- Green Control DMX Values

DMX Value	%	Effect
0-10	0-4	No Effect
11-20	5-8	Full Minus Green
21-119	8-46	-99% to -1%
120-145	47-57	Neutral
146-244	57-96	1% to 99%
245-255	96-100	Full Plus Green

DMX Profiles (FX)

When using as multiple pixels, patch in a fixture for each set of channel per pixel. The FX parameters are for the entire light.

#	Name	Bit Depth	# of Channels Per Pixel	# of FX Channels	Channel Description
9	HSIC-FX	8 Bit	5	3	1: Intensity 2: Color Temp 3: +/- Green Control 4: Hue 5: Saturation 6: FX 7: FX Rate 8: FX Size
10	HSIC-FX	16 Bit	7	3	1+2: Intensity 3: Color Temp 4: +/- Green Control 5+6: Hue 7: Saturation 8: FX 9: FX Rate 10: FX Size
11	CCT & RGB-FX	8 Bit	7	3	1: Intensity 2: Color Temp 3: +/- Green Control 4: Crossfade 5: Red 6: Green 7: Blue 8: FX 9: FX Rate 10: FX Size
12	CCT & RGB-FX	16 Bit	9	3	1+2: Intensity 3: Color Temp 4: +/- Green Control 5+6: Crossfade 7: Red 8: Green 9: Blue 10: FX 11: FX Rate 12: FX Size

DMX Profiles (FX) Parameters

Parameters

Effect	DMX Value	%
OFF	0-27	0 - 10
Rainbow	28-38	11-15
Short Circuit	41-53	16-20
Paparazzi	54-68	21-25
Strobe	69-78	26-30
Fire	79-91	31-35
Emergency Lights	92-104	36-40
Demo	105-116	41-45
No Effect	117-255	46-100

Effects Parameters

Item	Result
Effect	Choose effect
Intensity	Set intensity of effect
Color Temp	Set base color temp
+/- Green	Set +/- green of the color temp
Saturation	Saturate the effect
Hue	Set the hue
Rate	0-200% for the speed of the effect 100% is normal speed

DMX Profiles (Extended FX)

When using as multiple pixels, patch in a fixture for each set of channel per pixel. The FX parameters are for the entire light.

#	Name	Bit Depth	# of Channels Per Pixel	# of FX Channels	Channel Description
15	HSIC-EXT-FX	8 Bit	5	7	1: Intensity 2: Color Temp 3: +/- Green Control 4: Hue 5: Saturatio 6: FX 7: FX Rate 8: FX Size 9: FX ColorTemp2 10: FX +/- Green2 11: FX Hue2 12: FX Saturation2
16	HSIC-EXT-FX	16 Bit	7	8	1+2: Intensity 3: Color Temp 4: +/- Green Control 5+6: Hue 7: Saturation 8: FX 9: FX Rate 10: FX Size 11: FX ColorTemp2 12: FX +/- Green2 13+14: FX Hue2 15: FX Saturation2
17	CCT & RGB - EXT-FX	8 Bit	7	9	1: Intensity 2: Color Temp 3: +/- Green Control 4: Crossfade 5:Red 6: Green 7: Blue 8: FX 9: FX Rate 10: FX Size 11: FX ColorTemp2 12: FX +/- Green2 13: Crossfade2 14: Red2 15: Green2 16: Blue2
18	CCT & RGB - EXT-FX	16 Bit	9	8	1+2: Intensity 3: Color Temp 4: +/- Green Control 5+6: Crossfade 7: Red 8: Green 9: Blue 10: FX 11: FX Rate 12: FX Size 13+14: Crossfade2 15: Red2 16: Green2 17: Blue2

*Please refer to page 23 for parameters

Basic Specifications

Model	RR50	RR100
Wattage	Max 50 watts	Max 100 watts
Weight	3.30 lbs (1.5 kg)	5.73 lbs (2.6 kg)
Dimensions	22.7 x 3.34 x 2.04 in (577 x 84.8 x 51.8 mm)	46.1 x 3.34 x 2.04 in (1171 x 84.8 x 51.8 mm)
Power Consumption	120v = 0.44 amp 240v = 0.22 amp 12v = 3.80 amp 24v = 1.90 amp	120v = 0.88 amp 240v = 0.44 amp 12v = 7.60 amp 24v = 3.80 amp

Warranty

3 Year warranty from date of purchase.
Customer must provide proof of purchase.
This warranty is transferable.

Quasar Science will pay for:
The replacement parts, repair and/or labor costs to correct defects in materials and workmanship.
Service must be provided by Quasar Science or an Authorized Quasar Science Service Center

Quasar Science will not pay for:
Damage resulting from accident, misuse or abuse. Acts of God. Any failure that occurs for any other reason than materials and workmanship. Any shipping or handling costs.

Disclaimer of implied warranties / limitations of remedies:
Implied warranties, including the extent applicable warranties of merchantability or fitness for a particular purpose are excluded to the extent legally permissible. Any implied warranties that may be imposed by law are limited to 3 years or the shortest period allowed by law. Some states, provinces or countries do not allow limitations or exclusions on how long an implied warranty of merchantability or fitness lasts, the above limitations or exclusions may not apply to you.

If this product fails to work as warranted, customer's sole and exclusive remedy shall be repair or replacement according to the terms of this limited warranty. Quasar Science, LLC does not assume any responsibility for incidental or consequential damages. This warranty gives you specific legal rights and you may also have other rights which vary from state to state, province to province or country to country.

RR LED Linear Light Quick Start Guide

Please do not return your light to your retailer.
Contact Quasar Science with any questions, problems or concerns.



687 S. Anderson St.
Los Angeles, CA 90023
info@quasarscience.com
(800) 876-0665

V1.0