

# QUASAR SCIENCE

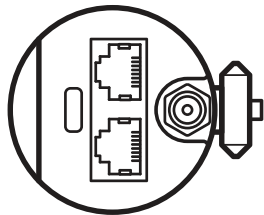
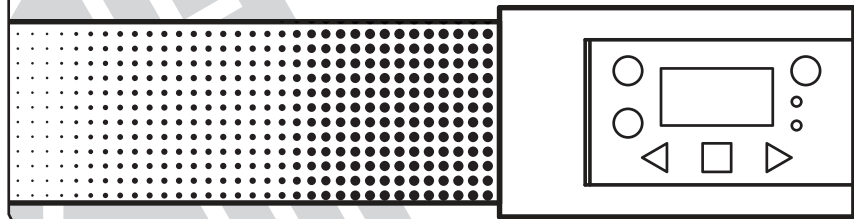

**R2**  
LED Linear Light

**Quick Start Guide**

Download Full Manual at [QUASARSCIENCE.COM/R2](http://QUASARSCIENCE.COM/R2)

# What's in the Box

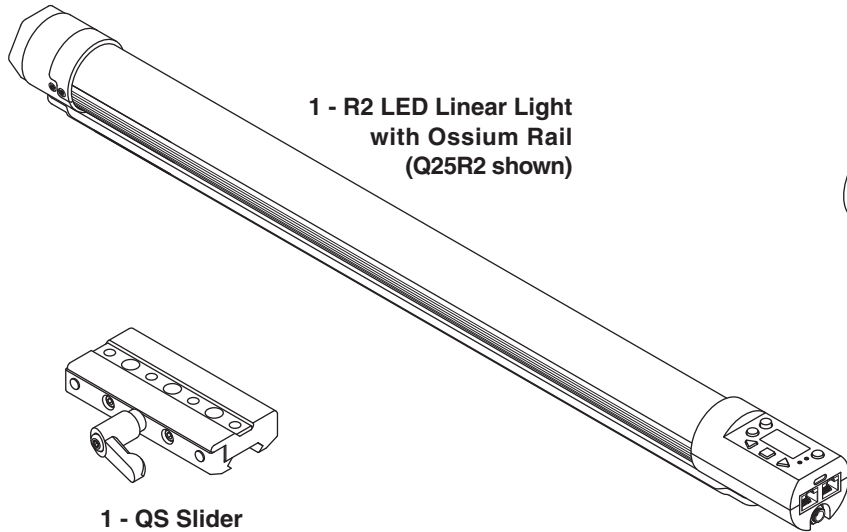

1 - R2 LED Linear Light  
with Ossium Rail  
(Q25R2 shown)

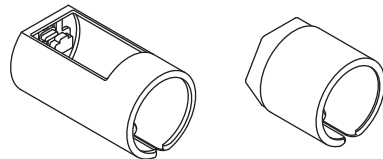

2 - Q-Boot Silicon Bumpers

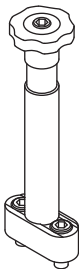

1 - QS Dual Screw  
Baby Pin

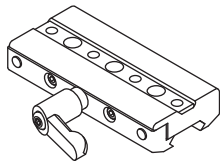

1 - QS Slider

- 1 - 8ft AC Power Cable
- 1 - 8ft DC Power Cable:  
P-TAP to 2.1mm Barrel
- 1 - Quick Start Guide
- 1 - Short Cut Guide
- 1 - 3/16 Hex Wrench

# R2 Overview

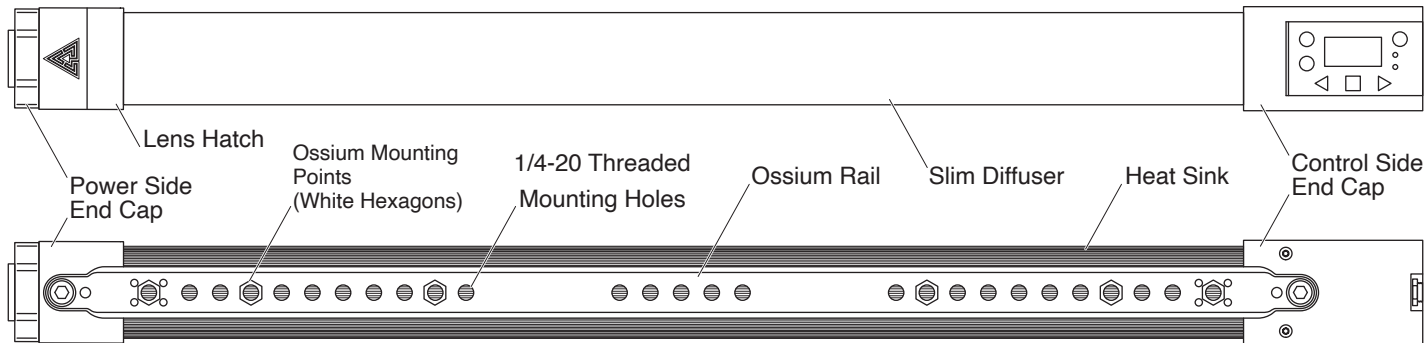

\*Q25R2 shown as reference

# R2 Interface Layout

## Power Side

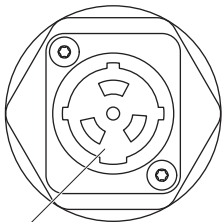

AC IN Port

## Control Side

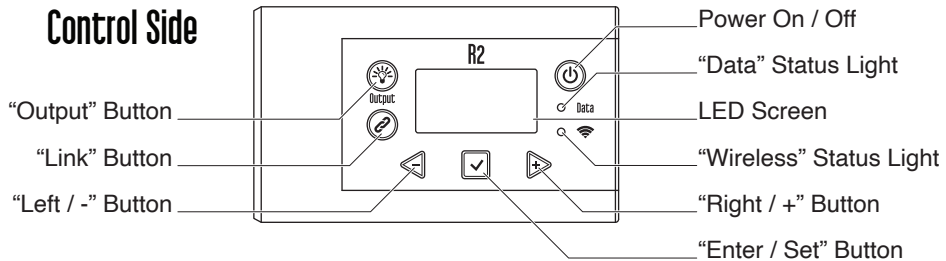

"Output" Button

"Link" Button

"Left / -" Button

Power On / Off

"Data" Status Light

LED Screen

"Wireless" Status Light

"Right / +" Button

"Enter / Set" Button

USB-C Update Port

LAN1 / DMX IN

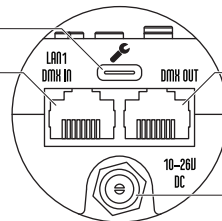

DMX OUT

DC IN Port:  
2.1mm x 5.5mm



# Mounting R2

Mount Dual Screw Baby Pin directly to the light using 3/16 Hex wrench.

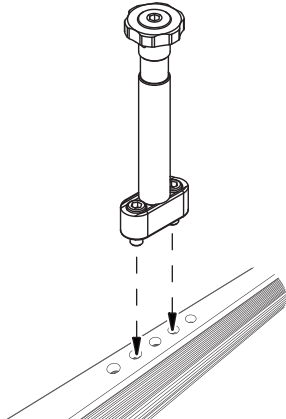

Mount Dual Screw Baby Pin to Ossium Rail Slider using 3/16 Hex wrench for added convenience and versatility.

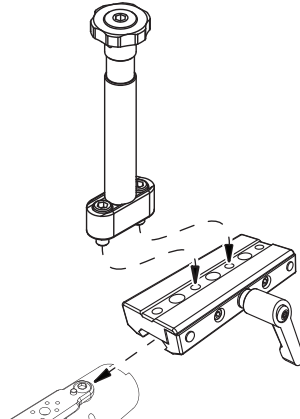

Mount Rotator\* using 5/32 hex wrench directly to the light.

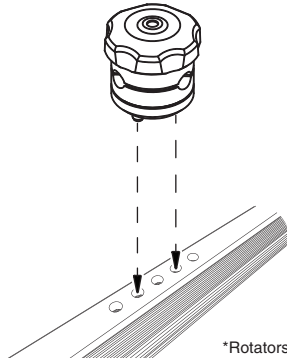

Mount Rotator\* using 5/32 hex wrench to Ossium Rail Slider for added convenience and versatility.

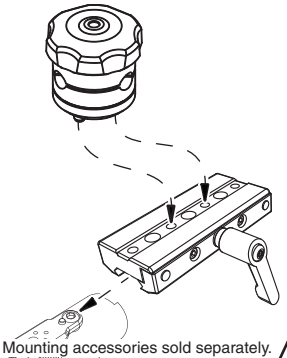



\*Rotators and other Ossium Mounting accessories sold separately.

# Getting Started

•To set the **Intensity, Color Temp, +/- Green, Saturation** and **Hue**:

1. Press ◀ or ▶ until desired function is shown on screen, and press  to select.
2. The selection carets "> <" will move from the ">**Function**<" to the ">**Value**<".
3. Press ◀ or ▶ to set the value. Press  to save.
4. The selection carets "> <" will move from the ">**Value**<" back to the ">**Function**<".

•To link an RR or R2 light to a CRMX /Wireless DMX transmitter:





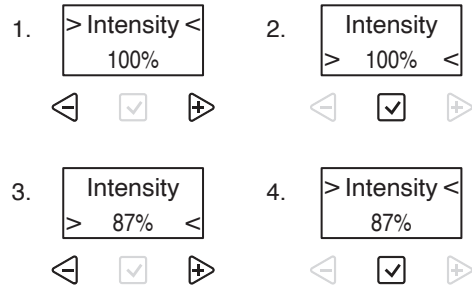

1. Double tap . Go to **Wireless Mode->Wireless DMX**.
2. If the "**Wireless**" **Status Light** is flashing, press and hold  to unpair.
3. On the DMX transmitter, tap the link button to pair.
4. The "**Wireless**" **Status Light** will start to flash and turn solid **green** once paired.

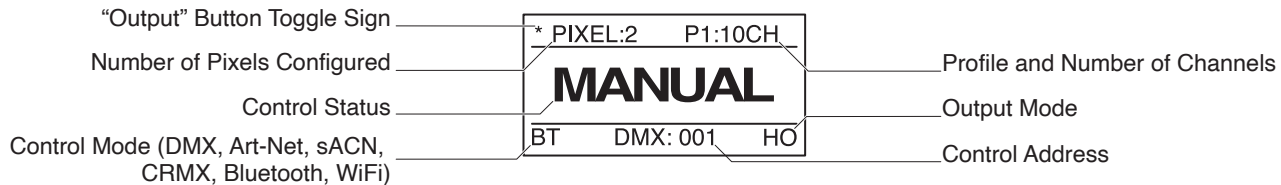
•When connected wirelessly to a DMX transmitter or **Leader**, the Wireless signal



# Key Interface





-  **Power Button:** Light On: Press and hold for 1 second. Light Off: Press and hold for 2 seconds. Double Tap: Go to Status Screen.
-  **Output Button:** Toggle the button to enable/disable light output for manual mode operation. Change the color/intensity without the change affecting the environment.
-  **Link Button:** On CRMX: For RX, press and hold to unlink light. For TX, Single tap to send pairing signal. Double Tap to bring up Wireless Menu (Pg 13.)
-  **Left / Minus Button:** Decrease a value or navigate Left.
-  **Right / Plus Button:** Increase a value or navigate Right.
-  **Enter / Save Button:** Enter selection, Save Value.
-  **Upgrade Port:** USB-C Port for performing software updates with a USB-C Thumb Drive.













# Status Lights

The **Data** and **Wireless Status Lights** can be various colors based on the connection type and status. Check that the light is in the correct wired and wireless modes and that Status lights are enabled in the config. See Page 8 for color combinations.

## Data LED

-  **Data** Solid LED – Data Received.
-  **Data** No Light – No Data Received or Status Lights turned off.

## Wireless LED

-   Solid LED – Connected to Wireless Device.
-     Slow Flashing – Light is paired with Wireless Device and connected, but Transmitter is not receiving data.
-     Fast Flashing – Light is connecting to Wireless Device or Lamp is paired with Wireless Device but device not found.
-   No Light – Light is Not Paired with Wireless Device, Wireless Mode -> Off or Status Lights turned off.



# Status Lights

## Local

- **Data Manual Mode**
-  Data: Off / Wireless: Off



## Lead/Follow - Wired

- **Data Wired Leader**
-  Data: Green / Wireless: Off
- **Data Wired Follower**
-  Data: Cyan / Wireless: Off





## Lead/Follow - Wireless

- **Data Wireless Leader**
-  Data: Green / Wireless: Purple
- **Data Wireless Follower**
-  Data: Cyan / Wireless: Purple

## Wired

- **Data DMX Mode / Data Received**
-  Data: Red / Wireless: Off
- **Data Ethernet Mode / Data Received**
-  Data: Yellow / Wireless: Off

## Wireless

- **Data Wireless DMX**
-  Data: Red / Wireless: Green (Or Universe Color)
- **Data WiFi Mode (Art-Net over WiFi)**
-  Data: Yellow / Wireless: Magenta
- **Data WiFi Access Point Mode (Art-Net over WiFi)**
-  Data: Yellow / Wireless: Orange
- **Data Bluetooth Mode**
-  Data: Blue / Wireless: Blue



\*Check Status Lights are enabled in Config

\*\*For Blink Pattern definition, view the full manual

Download Full Manual at [QuasarScience.com/Support](https://QuasarScience.com/Support)

# Button Shortcuts



**Min / Max Value Jump:** On parameter menus such as Intensity, Color Temperature, Saturation, Hue, and Effects Parameters,



While pressing and holding  to increase the value, tapping  will jump to the next value or max value.

While pressing and holding  to decrease the value, tapping  will jump to the next value or minimum value.

**Enable/Disable Status Lights:** Press and hold  for 5 seconds to disable the status lights. Press again for 5 seconds to enable.

**Enable/Disable RDM:** Press and hold   for 2 seconds to disable RDM. Press again for 2 seconds to enable.

**Enable/Disable Wireless:** Press and hold   for 2 seconds to disable all Wireless Functions. Press again for 2 seconds to enable.

**Reset to Default:** Press and hold   for 3 seconds to reset the light to Default settings.

**Link Button:** RX Mode - Press and hold  to unpair the light. TX Mode - Tap  to send pairing signal.

**Wireless Menu:** Double press  to open the Wireless Menu.

**Status Screen:** Double press  to return to the Status Screen. When on the Status Screen, Single press  to display additional info.

# Main Menu - Manual Mode

- > **Intensity** 0 to 100% by 1%
- > **Color Temp** 1,750K to 10,000K by 1 Just Notable Difference
- > **+/- Green** -G 100 to G 0 to +100 G -- Ex. +G 25 = 1/4 +Green, -G 50 = 1/2 -Green (Magenta),
- > **Saturation** 0 to 100% by 1%
- > **Hue** 0° to 360°
- > **CT Preset** 3,200K - 4,300K - 5,600K - 6,500K(D65) - 7,500K(D75) - 10,000K - 2,000K - 2,500K - 3,000K
- > **Color Preset** Red - Orange - Yellow - Green - Cyan - Blue - Violet - Magenta
- > **Effects** Rainbow - Short Circuit - Paparazzi - Strobe - Fire - Emergency Lights - Demo\* **(See Page 17-18)**
- > **Config** Light Settings **(See Page 11)**

\*Check the website for newly added effects

# Config Menu

- > **DMX Channel** Set the DMX Channel.
- > **Number of Pixels** Set the number of pixel groups in the light to control in groups. **(See Page 12)**
- > **Profile** Set the DMX profile for the light. **(See Page 18-23)**
- > **Wired Settings** Select the Wired data options to control the light. (DMX, Art-Net, sACN) **(See Page 13)**
- > **Wireless Settings** Select the Wireless data options. (CRMX, Bluetooth, WiFi) **(See Page 14)**
- > **Lead / Follow** Set Lead/Follow mode for the light. **(See Page 15)**
- > **Output Mode** Set the light to Normal Output, High Output, or Low Output Mode. **(See Page 16)**
- > **Power On Mode** With Button, turns on with Power Button. With Input, turns on when power is connected. **(See Page 16)**
- > **Status Lights** Turns the status lights on/off for use on camera.
- > **Languages** English (Check the website for additional languages.)
- > **Lamp Hours** Displays the total hours the light has been powered on. Press Enter to See LED Hours.
- > **Update Firmware** Set the light into Update mode.
- > **Firmware** Displays the firmware version on the light.
- > **Reset to Default** Sets the light back to all its default values.

# Pixel Selection & Layout

- > **Number of Pixels**
  - 1, 2, 5, 10 - Available grouping options for the Q25R2's 10 individually controllable pixels.
  - 1, 2, 3, 4, 6, 8, 12, 24 - Available grouping options for the Q50R2's 24 individually controllable pixels.
  - 1, 2, 3, 4, 6, 8, 12, 16, 24, 48 - Available grouping options for the Q100R2's 48 individually controllable pixels.
- When choosing DMX profiles, each **Parameter Channel Group** are repeated per pixel.
  - When a Q100R2 is set to 1 Pixel for an example, it will control the entire light as 1 pixel and require 1 set of DMX Data to control it.
  - When a Q100R2 is set to 48 Pixels for an example, it will control the light as 48 pixels and require 48 sets of DMX Data to control it.
- The Layout of the pixels start from the "Gaffer's Left" when looking at the light projected towards the Gaffer, with the controls on the right side.

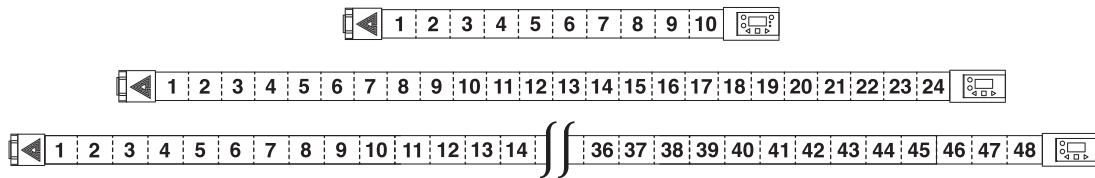

# Wired Control Menu

## > **Wired Mode**

### > **DMX**

Choose DMX512 or Ethernet Mode to Wire Control the light.

### > **Ethernet**

Control the light with DMX512.

Control the light with sACN or Art-Net.

## > **DMX Settings**

### > **DMX Channel**

Set the DMX Channel 001 to 512.

### > **Terminate**

Terminate the DMX Signal when last in line.

## > **Ethernet Settings**

### > **View IP Address**

Show the IP address automatically received through DHCP or the Static IP address set.

### > **IP Address Mode**

Set the IP Address Mode.

#### > **DHCP (Auto)**

Allow the light to obtain the IP address from the router automatically.

#### > **Static**

Allow the light to set the IP address manually.

### > **Save DHCP as Static**

Save the info received from the DHCP Router and save as a Static IP, changing Mode to Static.

### > **IP Address, Subnet Mask, Gateway**

Enter the IP address, Subnet mask, and Gateway.

### > **Universe**

Set the Universe for the light.

### > **DMX Channel**

Set the DMX Channel 001 to 512.

### > **Ethernet Mode**

Choose the Ethernet protocol: sACN/Art-Net, sACN Only, Art-Net Only.

# Wireless Control Menu

## > Wireless Mode

### > Wireless DMX

Lumen Radio CRMX wireless DMX. Press and hold  to Clear. Tap transmitter to pair.

### > Bluetooth

Enable the light to connect over Bluetooth.

### > WiFi

Enable the light to connect to a wireless network to receive Art-Net over WiFi.

### > Off

Turns off all Wireless functionality.

## > Wireless DMX Settings\*

Shows the Hardware and Firmware of the CRMX TimoTwo.

## > WiFi Settings\*

Connect to a Wireless Network to receive Art-Net over WiFi. Turn the light into a wireless access point to allow mobile device to set up wireless settings.

## > Status Lights On/Off

Turns off status lights for use when light is seen on camera.

## > Reset Wireless Settings to Default

Reset All Wireless Settings to factory default.



**Tip:** Double Tap  to bring up the Wireless Control menu.

\*See the full Manual for Detailed Descriptions of the Wireless DMX Settings and WiFi Settings.

## Lead/Follow Mode

- **Lead/Follow** mode allows one light to control many lights at once. The **Lead** transmits color and intensity data, wired or wirelessly, to the **Follows**. When the **Lead** changes levels, the **Follows** will change as well. This applies to on board FX as well.
- To use **Lead/Follow** mode, go to **Config -> Lead/Follow**. Set the leader to **Lead** and set all of the followers to **Follow 1** to match the leader. **Follow 2-8** are used with effects to do the same effect with different timings. This will run the same effects, intensities and levels but not in sync.



- To use **Lead/Follow** wired, plug a Cat5 cable into the **DMX OUT** port of the leader into the In of the followers. Repeat out of the followers and into the next. The **Data** light should be illuminated on all the followers.
- To use **Lead/Follow** wirelessly, after setting to Lead or Follow 1-8, set **Wireless Mode** to “**CRMX**”. Then on the follows, press and hold  to unpair the light. Next tap  on the leader. On all of the followers, the **Wireless** signal light should begin flashing and then remain solid. See page 8 for **Lead/Follow** status light color combinations.



## Output Mode

•There are 3 different **Output Modes**, which are used to increase the light output or the resolution in different areas of the dimming range.

- > **Output Mode**
- Normal Output:** Normal operating temperature, standard light output.
  - High Output:** High operating temperature, maximum light output.
  - Low Output:** Gives maximum resolution in the low dimming section of the light. Maximum power is about 25% of High Output.



**Output Mode** is shown in the bottom right of the **Status Screen** - HO = **High Output**, LO = **Low Output**, None = **Normal**

## Power On Mode

•**Power On** mode is used to define how to turn on the light.

- > **Power On**
- with Button:** Uses the Power button to turn on after connecting power. Normal Operation.
  - with Input:** Turns on when power is applied, bypassing the power button. Useful when rigged into a set or out of reach.

# Effects (Manual)

## Main Menu

| Effect           | Result  |
|------------------|---|
| Rainbow          | Scroll through the hue from 0° at full saturation |
| Short Circuit    | Light is on with random bursts of turning off     |
| Paparazzi        | Light is off with random flashes of turning on    |
| Strobe           | Rhythmic flashes on                               |
| Fire             | A fire flicker effect                             |
| Emergency Lights | Flashing lights of various colors                 |
| Demo             | Scrolls through the Hue Wheel and all Effects     |

## Effects Parameters

| Item        | Result                                |
|-------------|---------------------------------------|
| Effect      | Choose effect                         |
| Intensity   | Set Intensity of effect               |
| Color       | Set base color temp                   |
| Temp        | Set +/- green of the color temp       |
| +/- Green   | Saturate the effect                   |
| Saturation  | Set the hue                           |
| Hue<br>Rate | 0-200% for the speed of the<br>effect |
|             | 100% is normal speed                  |

\*Check the website for newly added effects.

## Effect Controls (Manual)

### Fire

| Weight  | Result   |
|---------|--|
| Rate    | 0-200% for the speed of the effect<br>100% is normal speed |
| Maximum | Highest intensity level of effect                          |
| Minimum | Lowest intensity level of effect                           |
| Weight  | Low, Centered, High  |
| Preset  | +/-400K Color at 2400K, 3200K, 4000K, 5600K                |

### Emergency Light Submenu

| Item          | Result  |
|---------------|---|
| Pattern       | Single, Double, Triple, Quad  |
| Color Presets | R&B, B&B, R&32, R&56, B&32, B&56<br>R&B&32, R&B&56                              |
| Color 1 & 2   | Red, Orange, Yellow, Green, Blue, Magenta,<br>2000K, 3200K, 4000K, 5600K, 6000K |

# DMX Profiles & Pixel Patching

DMX Profiles for the lights come in 2 types. Basic DMX Profiles that include HSIC, RGB, CCT modes and FX Profiles that have additional channels to trigger the built in FX.

## **DMX Profiles (Basic)**

**P1-8**

Different DMX channel arrangements to control the Parameters for your light.

**P13, 14**

Direct control of the 5 available colors channels; Red, Green, Blue, 2000K, 6000K  
(See Page 21)

When programming the light pixels, each **Pixel** acts as its own single “light” unit, ie, a **Parameter Channel Group** (PCG). Each **PCG** contains a set of DMX channels defined by the selected **DMX Profile**, to control a given pixel.

## **DMX Profiles (FX)**

**P9-12**

Control the basic parameters of the lamp and allow control of the built-in effects of the light. (See Page 23)

The FX Profiles are built upon the same profiles as the Basic Profiles. For example. Profile 9 is Profile 1 + FX Channels.

When using DMX profiles with built in FX, an **FX Channel Group** (FCG) is added at the end of the patch. Changes in the **FCG** applies to the entire light.

# DMX Pixel Patching Examples

If the **Number of Pixels = 1**, the entire fixture functions as 1 group controlled by the currently set DMX Profile. For DMX Profile = "1: HSIC Mode – 8 Bit – 5 Channels", that group has 5 DMX control channels:

1. Intensity (%)
2. Color Temp (K)
3. +/- Green (-G 100 to +G 100)
4. Hue (deg)
5. Saturation (%)

Example 1:

Number of Pixels: 4 - Profile 1 (P1): HSIC Mode – 8 Bit – 5 Channels per PCG - 20 Channels

| PCG 1 |     |     |     |      | PCG 2 |     |     |     |      | PCG 3 |     |     |     |      | PCG 4 |     |     |     |      |
|-------|-----|-----|-----|------|-------|-----|-----|-----|------|-------|-----|-----|-----|------|-------|-----|-----|-----|------|
| Int%  | CCT | ± G | Hue | Sat% | Int%  | CCT | ± G | Hue | Sat% | Int%  | CCT | ± G | Hue | Sat% | Int%  | CCT | ± G | Hue | Sat% |
| 1     | 2   | 3   | 4   | 5    | 6     | 7   | 8   | 9   | 10   | 11    | 12  | 13  | 14  | 15   | 16    | 17  | 18  | 19  | 20   |

Example 2:

Number of Pixels: 2 - Profile 9 (P9): HSIC FX Mode – 8 Bit – 5 Channels per PCG + 3 Channels for FCG (FX Channel Group) - 13 Channels

| PCG 1 |     |     |     |      | PCG 2 |     |     |     |      | FCG |      |      |
|-------|-----|-----|-----|------|-------|-----|-----|-----|------|-----|------|------|
| Int%  | CCT | ± G | Hue | Sat% | Int%  | CCT | ± G | Hue | Sat% | FX  | Size | Rate |
| 1     | 2   | 3   | 4   | 5    | 6     | 7   | 8   | 9   | 10   | 11  | 12   | 13   |

## DMX Profiles (Basic)

| #  | Name            | Bit Depth | # of Channels Per Pixel | Channel Description   |
|----|-----------------|-----------|-------------------------|---|
| 1  | HSIC            | 8 Bit     | 5                       | 1: Intensity 2: Color Temp 3: +/- Green Control 4: Hue 5: Saturation                        |
| 2  | HSIC-16         | 16 Bit    | 8                       | 1+2: Intensity 3: Color Temp 4: +/- Green Control 5+6: Hue 7+8: Saturation                  |
| 3  | HSI             | 8 Bit     | 3                       | 1: Intensity 2: Hue 3: Saturation   |
| 4  | XFade with +/-G | 8 Bit     | 3                       | 1: Intensity 2: Color Temp 3: +/- Green Control   |
| 5  | XFade           | 8 Bit     | 2                       | 1: Intensity 2: Color Temp  |
| 6  | CCT & RGB       | 8 Bit     | 7                       | 1: Intensity 2: Color Temp 3: +/- Green Control 4: Crossfade 5: Red<br>6: Green 7: Blue     |
| 7  | CCT & RGB-16    | 16 Bit    | 9                       | 1+2: Intensity 3: Color Temp 4: +/- Green Control 5+6: Crossfade<br>7: Red 8: Green 9: Blue |
| 8  | RGB             | 8 Bit     | 3                       | 1: Red 2: Green 3: Blue   |
| 13 | RGBTD           | 8 Bit     | 5                       | 1: Red 2: Green 3: Blue 4:2000K 5: 6000K  |
| 14 | RGBTD           | 16 Bit    | 10                      | 1+2: Red 3+4: Green 5+6: Blue 7+8:2000K 9+10: 6000K   |

# DMX Profiles (Basic) Parameters

## Available Parameters based on Profile

| Parameter  | DMX Value | Value              |
|------------|-----------|--------------------|
| Intensity  | 0-255     | 0 - 100%           |
| Color Temp | 0-255     | 1,750K-10,000K     |
| +/- Green  |           | See Chart at right |
| Hue        | 0-255     | 0° - 360°          |
| Saturation | 0-255     | 0 - 100%           |
| Crossfade  | 0-255     | 0 - 100%           |
| Red        | 0-255     | 0 - 100%           |
| Green      | 0-255     | 0 - 100%           |
| Blue       | 0-255     | 0 - 100%           |

## +/- Green Control DMX Values

| DMX Value | %      | Effect           |
|-----------|--------|------------------|
| 0-10      | 0-4    | No Effect        |
| 11-20     | 5-8    | Full Minus Green |
| 21-119    | 8-46   | -99% to -1%      |
| 120-145   | 47-57  | Neutral          |
| 146-244   | 57-96  | 1% to 99%        |
| 245-255   | 96-100 | Full Plus Green  |

## DMX Profiles (FX)

| #  | Name                       | Bit Depth | # of Ch Per Pixel | # of FX Ch | Parameter Channel Group (Repeated per Pixel)  | FX Channel Group (One Group per Light)   |
|----|----------------------------|-----------|-------------------|------------|---|--|
| 9  | <b>HSIC-FX</b>             | 8 Bit     | 5                 | 3          | 1: Intensity 2: Color Temp 3: +/- Green<br>4: Hue 5: Saturation                     | x+1: FX x+2: FX Rate<br>x+3: FX Size<br><br>x = Total Number of Channels in Parameter Channel Groups |
| 10 | <b>HSIC-FX-16</b>          | 16 Bit    | 8                 | 3          | 1+2: Intensity 3: Color Temp 4: +/- Green<br>5+6: Hue 7+8: Saturation               |  |
| 11 | <b>CCT &amp; RGB-FX</b>    | 8 Bit     | 7                 | 3          | 1: Intensity 2: Color Temp 3: +/- Green<br>4: Crossfade 5: Red 6: Green 7: Blue     |  |
| 12 | <b>CCT &amp; RGB-FX-16</b> | 16 Bit    | 9                 | 3          | 1+2: Intensity 3: Color Temp 4: +/- Green<br>5+6: Crossfade 7: Red 8: Green 9: Blue |  |



# DMX Profiles (FX) Parameters

## FX Selection

| Effect           | DMX Value | %      |
|------------------|-----------|--------|
| OFF              | 0-26      | 0-10   |
| Rainbow          | 27-38     | 11-15  |
| Short Circuit    | 39-51     | 16-20  |
| Paparazzi        | 52-64     | 21-25  |
| Strobe           | 65-77     | 26-30  |
| Fire             | 78-90     | 31-35  |
| Emergency Lights | 91-102    | 36-40  |
| Future Use       | 103-255   | 41-100 |

## Effects Parameters

| Item       | Result   |
|------------|--|
| Effect     | Choose effect  |
| Intensity  | Set intensity of effect  |
| Color Temp | Set base color temp  |
| +/- Green  | Set +/- green of the color temp  |
| Saturation | Saturate the effect  |
| Hue        | Set the hue  |
| Rate       | 0-200% - Speed of the effect<br>100% - Normal speed  |
| Size       | Fire Effect: Set the +/- of the Intensity<br>Ex: Int 50%, FX Size 10 = 50-10, and 50+10. Result = 40-60 Fire<br>Emerg Light: Set the Blink Pattern |

## Basic Specifications

| Model                    | Q25R2  | Q50R2  | Q100R2   |
|--------------------------|--|--|--|
| <b>Wattage</b>           | Max 25 watts   | Max 50 watts   | Max 100 watts  |
| <b>Weight</b>            | 1.76 lbs (0.8 kg)  | 3.3 lbs (1.5 kg)   | 5.84 lbs (2.64 kg)                                       |
| <b>Dimensions</b>        | 23 x 1.75 in<br>(584.2 x 44.5 mm)  | 46.9 x 1.75 in<br>(1161.7 x 44.5 mm)                                       | 90.86 x 1.75 in<br>(2307.8 x 44.5 mm)                    |
| <b>Power Consumption</b> | 120v = 0.25 amp<br>240v = 0.13 amp<br><br>12v = 2.50 amp<br>24v = 1.30 amp | 120v = 0.45 amp<br>240v = 0.25 amp<br><br>12v = 4.50 amp<br>24v = 2.30 amp | 120v = 0.90 amp<br>240v = 0.50 amp<br><br>24v = 4.80 amp |

# Warranty

3 Year warranty from date of purchase.  
Customer must provide proof of purchase.  
This warranty is transferable.

Quasar Science will pay for:  
The replacement parts, repair and/or labor costs to correct defects in materials and workmanship.  
\*Service must be provided by Quasar Science or an Authorized Quasar Science Service Center\*

Quasar Science will not pay for:  
Damage resulting from accident, misuse or abuse. Acts of God. Any failure that occurs for any other reason than materials and workmanship. Any shipping or handling costs.

Disclaimer of implied warranties / limitations of remedies:  
Implied warranties, including the extent applicable warranties of merchantability or fitness for a particular purpose are excluded to the extent legally permissible. Any implied warranties that may be imposed by law are limited to 3 years or the shortest period allowed by law. Some states, provinces or countries do not allow limitations or exclusions on how long an implied warranty of merchantability or fitness lasts, the above limitations or exclusions may not apply to you.

If this product fails to work as warranted, customer's sole and exclusive remedy shall be repair or replacement according to the terms of this limited warranty. Quasar Science, LLC does not assume any responsibility for incidental or consequential damages. This warranty gives you specific legal rights and you may also have other rights which vary from state to state, province to province or country to country.

# R2 LED Linear Light Quick Start Guide

**Please do not return your light to your retailer.**

Contact Quasar Science with any questions, issues or concerns.



687 S. Anderson St.  
Los Angeles, CA 90023  
support@quasarscience.com  
(800) 876-0665

Sign up to receive email updates on new firmware releases and downloadable guides at [QuasarScience.com/Support](https://www.QuasarScience.com/Support).

U1.5