

INSTRUCTION MANUAL

PNEUMATIC ORBITAL SANDER

Please read this manual carefully before you attempt to use your tool so that you may use it properly and safely.

ORBITAL SANDER Model OSV-60A PROFESSIONAL TOOL



Specifications

Model		OSV-60A
Maximum Operating Pressure	MPa	0.6
Air Consumption (No Load)	m ³ /min	0.68
Rated Speed (No Load)	min ⁻¹	8,500
Orbit Diameter	mm(inch)	10 (3/8)
Abrasive Paper Size	mm(inch)	150 (6)
Mass (Weight)	kg	2
Sound Pressure Level	dB(A)	88
Sound Power Level	dB(A)	99
Vibration Level [Uncertainty K]	Main Handle m/s ² [m/s ²]	4.6 [0.93]
	Housing m/s ² [m/s ²]	7.2 [1.17]
Thread Size of Air Inlet		Rc1/4

Due to continuous product development/improvement the specifications and configurations in this document are subject to change without prior notice.



Manufactured by :

NITTO KOHKI Co., Ltd.

2-9-4, Nakaikegami, Ohta-ku,
Tokyo, 146-8555, Japan

Tel : (81)-3-3755-1111

Fax : (81)-3-3753-8791

E-mail : overseas@nitto-kohki.co.jp

URL : www.nitto-kohki.co.jp

Keep the manual handy – so you can use it whenever necessary.

Original Instructions

Thank you very much for your purchase of this **Nitto Kohki products**.





Before using your tool, please read this manual carefully so that you may use it properly to get the most out of it.

Please keep the manual handy - so you can use it whenever necessary.



- **English** : Please ask your dealer or distributor for instruction manual in local language(s).
- **German** : Bitte fragen Sie Ihren Händler nach eine Betriebsanleitung in Landessprache.
- **French** : S'il vous plait, veuillez demandez á votre fournisseur de manuel instruction en langue locale.
- **Spanish** : Por favor, contacte con su distribuidor para el manual de instrucciones en español.
- **Portuguese** : Por favor pessa ao seo agente ou distribuidor o manual de instrucces ih linguagen local.
- **Italian** : Per Manuale Istruzioni in lingua locale Vi preghiamo di rivolgervi al rivenditore o distributore.
- **Dutch** : Vraag uw handelaar om een nederladstalige gebruiksaanwijzing.
- **Swedish** : Be er lokala Åtreförsäljare eller distributör om manualer pá svenska.
- **Danish** : Venligst henvend Dem til den danske distributør for instructions manualer.
- **Polish** : Proszę pytać swojego dealera lub dystrybutora o instrukcje obsługi w języku localnym.
- **中文** : 請向當地供應商或經銷商詢問中文使用說明書

CONTENTS	page
IMPORTANT SAFETY INSTRUCTIONS	2
GENERAL: TOOLS	2
GENERAL: PNEUMATIC TOOLS	3
INSTRUCTIONS FOR THIS TOOL	4
1. USAGE	4
2. CHECK THE CONTENTS OF THE PACKAGE	4
3. AIR SUPPLY	4
4. PREPARATIONS	4
5. ATTACH ABRASIVE PAPER	5
6. HOW TO OPERATE THE TOOL.....	5
7. REPLACING THE PAD.....	5
8. STORAGE	6
9. ORDERING SERVICE PARTS	6
10. EXPLODED DIAGRAM : OSV-60A.....	7

PICTOGRAM

-  Warning: It might be dangerous to operate the tool if the instructions supplied are not followed.
-  Using this tool improperly could result in serious injury.
Read the instruction manual before using.
-  Always wear suitable eye protection.
-  Always wear suitable hearing protection.
-  Always wear respiratory protective equipment (PPE).

The following Safety notations are used throughout the manual to highlight safety precautions for the user and for the tool.

 WARNING:	Indicates a potentially hazardous situation which, if not avoided by following the instructions given, could result in death or serious injury.
 CAUTION:	Indicates a potentially hazardous situation which, if not avoided by following the instructions given, could result in injury or material damage.

Please note, however, that failure to observe safety precautions under the “ **Caution**” category could result in a serious occurrence depending on the situation: please observe all safety precautions in the manual.

Caution: Important precautions for tool setup, operation and maintenance.

IMPORTANT SAFETY INSTRUCTIONS

When using the tool, please observe the safety precautions below to prevent possible accident or injury.

GENERAL: TOOLS

WARNING

TO OPERATORS

- **Wear proper clothing for the type of work being done.**
Take care so that clothing, ties, hair etc. Will not become entangled with the moving parts. If items become entangled it will cause the operator to be pulled towards the tool and lead to possible cause of accident or injury.
- **Always wear suitable eye protection.**
Remember, regular glasses are not safety glasses. The lenses are only shock resistant, which will not give you sufficient eye protection you may need in your working environment.
- **Always wear suitable hearing protection.**
- **Wear respiratory protective equipment (PPE).**
Wear respiratory protective equipment (PPE) when working in an environment where dust particles are generated in operation.
- **Avoid working posture that is too stressful.**
Always ensure a firm footing and well balanced posture.
- **Do not operate the tool if you are too tired.**
- **Never touch any moving parts of the tool when running.**

ABOUT WORK AREA

- **Keep the work area clean.**
Cluttered work areas (e.g. workbench) invite accidents.
- **Carefully select the work area.**
Do not expose tool to rain.
Do not use tool in a wet or soaked area.
See that the work area is adequately illuminated.
- **Never work near inflammable liquid or in a potentially explosive atmosphere.**
- **Keep children away from the work area.**
Keep children and unauthorized people away from the work area to avoid accident or injury.

BEFORE OPERATION

- **Inspect tool before use.**
Before using, check that screws are securely tightened, that any protective cover or guard is securely in place, other parts are free from damage and that the tool runs as it should.
Check that moving parts are properly adjusted for positioning and tightened, that parts are free from damage and properly mounted, and that all other parts are in good condition for normal operation.
Should you find any damage to the protective cover or other part, replace it in accordance with the Operation Manual. If there are no instructions in the Manual, please contact the sales agent through which you have purchased your tool or an authorized dealer near you for repair.
Likewise, if a switch failure occurs, contact sales agent through which you have purchased your tool or an authorized dealer near you for repair.
Do not use the tool if it does not start or stop with the start/stop switch.
 - **Securely mount cutter.**
An improperly mounted cutter may fly out, causing possible damage to the tool or injury to the operator.
 - **Always remove spanner, wrench, etc., once adjustment has been made with them.**
 - **Use a tool appropriate for the application.**
Avoid heavy-duty application that is beyond the capacity of tool.
 - **Do not use the tool for purposes other than what it is designed for.**
 - **Do not abuse tool.**
Use tool in accordance with the specifications: you'll get the most out of it while ensuring safety.
 - **Securely fasten workpiece in place.**
Use a vice or clamp to securely fasten the workpiece in place. It is much safer this way than holding it in your hand, allowing you to operate the tool with both hands.
- #### ABOUT HANDLING
- **How to store tool.**
When the tool is not used, store it in a dry area and out of reach of children.
 - **How to carry tool.**
Do not touch the start switch while the tool is being carried.
 - **Do not leave the tool unattended while it is running.**
Turn off the start switch and disconnect the tool from power source. Do not leave the work area until the tool comes to a complete stop.

MAINTENANCE/SERVICE

- **Do not take apart or modify tool.**
Disassembly or modification carried out without the supervision of a qualified or authorized service engineer could result in an accident or injury.
- **Inspect cutting tool and accessories, etc.**
Always check to see that cutting tool and accessories, etc. are in good operating condition without damage or deterioration before you mount them on the tool. Should you find any damage to an accessory or part, please contact sales agent through which you have purchased your tool or an authorized dealer near you for repair.
- **Check parts for damage.**
When you have found damage to accessory or other part, carefully check the damaged part to determine the extent of influence it has upon the functions of the tool – that is, determine whether it can still perform its normal functions.
Check to see that the linkage of the moving parts is OK, that all parts are OK without damage, that they are properly mounted, and that the tool functions normally. Should you find any damage to an accessory or part that may hamper proper functioning of the tool, please contact sales agent through which you have purchased your tool or an authorized dealer near you for repair.
- **Have your tool repaired at an authorized Nitto Service Center.**
For repair or parts replacement, please contact the sales agent through which you have purchased your tool or an authorized dealer near you.
- **Use only Nitto genuine parts.**
Use of improper parts may result in serious accident. To obtain a Nitto genuine part, consult this Manual or contact the sales agent from which you have purchased your tool directly.
- **Do not detach label or nameplate from tool.**
When a label/nameplate gets damaged, worn or becomes missing, contact the sales agent through which you have purchased your tool or Nitto Kohki Co. Ltd, directly for a replacement.

DISPOSAL

- When a tool is taken permanently out of service, it is advised that the tool is disassembled, degreased and parts separated by material and recycled locally in the appropriate manner.

GENERAL:PNEUMATIC TOOLS

WARNING

- **Use appropriate air pressure.**
Excessively high air pressure will increase the tool number of revolutions or strokes causing not only potential premature failure/breakage but could also lead to an unexpected accident or injury.
- **Connect tool to air supply line.**
There are various types of pipes running in a factory in addition to the pneumatic line (such as oxygen, nitrogen, gas and water). For this reason, always ensure that you are connecting to the pneumatic line.
- **Start tool properly.**
Turn the start switch OFF before connecting to the air supply line.
- **Always disconnect the tool from the air supply line before putting on/taking off any accessory and prior to carrying out any maintenance work.**
- **Avoid exposure to exhaust air.**
Pneumatic tool exhaust air contains oil and contaminated moisture. Make sure the exhaust air is not directed towards your face or anyone else within the work area.
- **Keep tool off electricity.**
This pneumatic tool is not electrically insulated. To avoid a potential electric shock do not use where there is a possibility of coming into contact with live electricity.

CAUTION

- **Handle tool carefully.**
Abusive use of tool could invite failure or accident. Do not throw, drop or shock the tool.
- **Handle connecting hose carefully.**
Do not carry the tool by the connecting hose. Do not pull the connecting hose to disconnect.

INSTRUCTIONS FOR THIS TOOL

About Your Tool

WARNING

- **Wear protective glasses and a dustproof mask.**
Operation generates chips and dust particles, etc. which may cause eye and/or respiratory injury. Always use PPE (Personal Protective Equipment) for eye and respiratory protection.
- **Always turn off the air supply and disconnect the air supply hose beforehand whenever replacing Abrasive Papers.**
- **Be sure to keep hands clear of moving parts.**
- **After mounting Pad, hold the Orbital Sander under a steelworkbench or safety place and run it for at least one minute.**
Make certain no one is within the operating direction of the Pad. If the Pad is defective, improperly mounted or the wrong size and speed, this is the time it will usually fail.
- **Air pressure at the sander inlet with the sander running must not exceed 0.6 MPa.**
- **Always replace damaged, bent or severely worn Pads.**
Do not use a Pad that has been subjected to an Abrasive Paper failure.

1. USAGE

This tool is for sanding workpieces using Abrasive Paper.

WARNING

This tool is not designed for water sanding. Never use for water sanding.

2. CHECK THE CONTENTS OF THE PACKAGE

Check the contents and make sure that the tool does not have any damage which may have occurred during transportation. The contents should correspond to the list as follows. In case of damage/missing parts, please contact the sales agent from whom you purchased the tool.

Package Contents	Qty	Check
ORBITAL SANDER OSV-60A	1set	
Spanner 17	1	
Bushing R1/4 x NPT1/4	1	
Brush	1	
Hose	1	
Dust Bag	1	
Hose Band	1	
Instruction Manual	1	
Declaration of Conformity	1	
Caution for Use	1	

3. AIR SUPPLY

3-1. Air Pressure

Adjust air pressure with the air regulator to the appropriate level for the pneumatic tool used.

Air pressure that is too low will stop the tool from operating at full capacity.

Air pressure that is too high may cause damage to the tool.

3-2. Air Line (Fig.1)

Use a 9.5 mm (3/8") I. D. connecting hose between the compressor and the tool.

Drained water, etc., if flown into the tool, could cause tool failure. Install an air filter between the compressor and the tool.

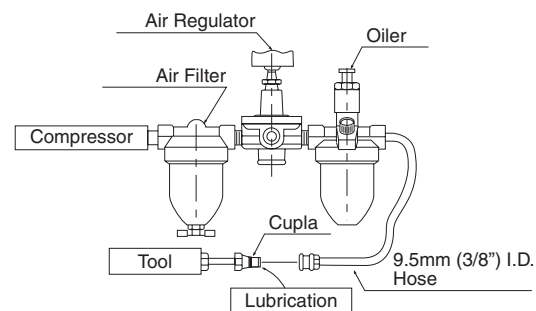

Fig. 1

3-3. Lubrication

Install an oiler between the compressor and the tool. Use the machine oil ISO VG-10. Failure to lubricate as required may result in damage to the tool. Use of oil that is too thick will reduce the performance of the tool.

4. PREPARATIONS

4-1. Thread Size of Hose Fitting

The product comes with a metal fitting with Rc(metric) thread. Connect the Bushing R thread x NPT thread included as standard accessories, if you would like to have American NPT thread instead.

4-2. How to assemble Hose and Dust Bag

Insert one end of Hose to the exhaust of the tool and tighten with Hose Band securely. Connect another end of the Hose to the Dust Bag or Dust Collector. Always keep the inside of the Hose Clean. Accumulated dust inside of the Hose will decrease not only the efficiency of dust collection but also the performance of the tool itself.

5. ATTACH ABRASIVE PAPER

! WARNING

Always turn off the air supply and disconnect the air supply hose beforehand whenever replacing Abrasive Papers.

Stick the Abrasive Paper onto the Pad with aligning their dust holes each other. Misalignment of those holes will decrease the performance of dust collection.

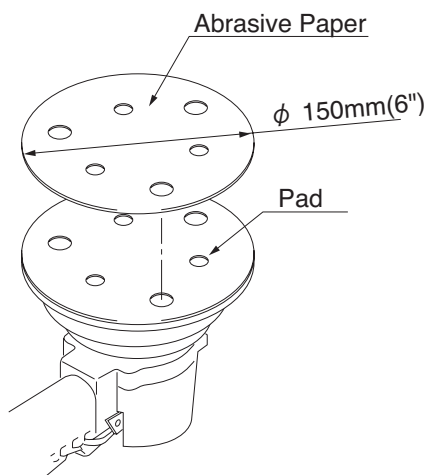

Fig. 2

6. HOW TO OPERATE THE TOOL

6-1. Start and Stop

To start: Release the Lock Lever and hold down the Throttle Lever.

To stop: Release the Throttle Lever.

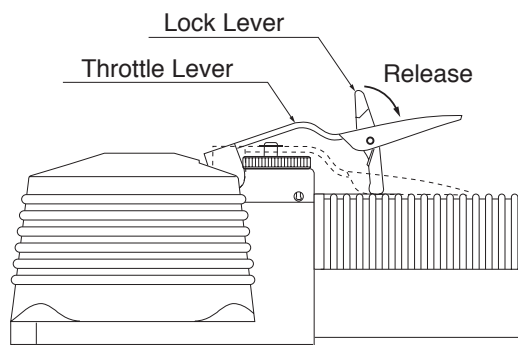

Fig. 3

6-2. Speed Adjustment

! WARNING

Be sure to keep hands clear of moving parts.

The Speed can be adjusted with a Regulator. Select a desired Speed by adjusting the Regulator.

Maximum Speed: Turn the Regulator dial clockwise

Minimum Speed: Turn the Regulator dial counterclockwise

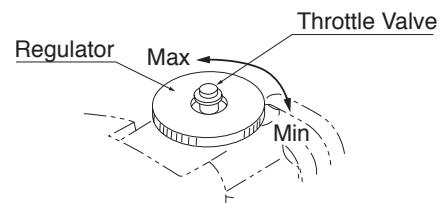

Fig. 4

6-3. How to Operate

Stick the Abrasive Paper onto the Pad. Hold the grip with one hand and lightly press the Pad against the work surface. Then hold the top of the Housing Cover with another hand. Turn on the Throttle Lever slightly. After making sure the smooth start-up, turn the Throttle Lever down completely to get the desired Speed. An excess power of pressing tools against the work surface cause slow down of the Speed of the Pad. It silt the abrasive paper and prevent the efficiency of the sanding work.

7. REPLACING THE PAD

! WARNING

Always turn off the air supply and disconnect the air supply hose beforehand whenever replacing the Pad.

Tighten the Pad securely. Insufficient tightening of screws may lead to unintended accidents.

To remove the Pad, hold the Spindle with the accessory Spanner 17 and turn the Pad counterclockwise by hand.

To attach the Pad, lock the Spindle with the accessory Spanner 17 and insert the screw located in the center of the Pad into the Spindle and fix by turning the Pad clockwise.

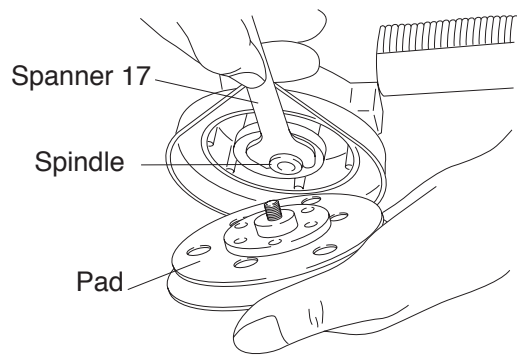

Fig. 5

8. STORAGE

CAUTION

When tool is not used, store it out of reach of children.

Avoid storing the tool in a location subject to high humidity. If the tool is left as it is used, residual moisture on the inside can cause rusting. Before storing, and after operation, oil the tool at the air inlet with machine oil ISO VG-10 and run it for a short time.

9. ORDERING SERVICE PARTS

For further operational and handling information or for replacement of parts and components, contact the company from whom you purchased the tool or an authorized dealer.

In ordering parts and components give each part number, part name and quantity required.

Use only NITTO genuine parts.

10. EXPLODED DIAGRAM : OSV-60A

WARNING

This diagram is for your reference only. Do not attempt to service or repair the Tool. Do not take the Tool apart. Contact an authorized Nitto dealer for all service and repair of the Tool. Improper service and repair can cause accidents and service injuries. Never attempt to modify the Tool. Never attempt service or repair the Tool yourself.

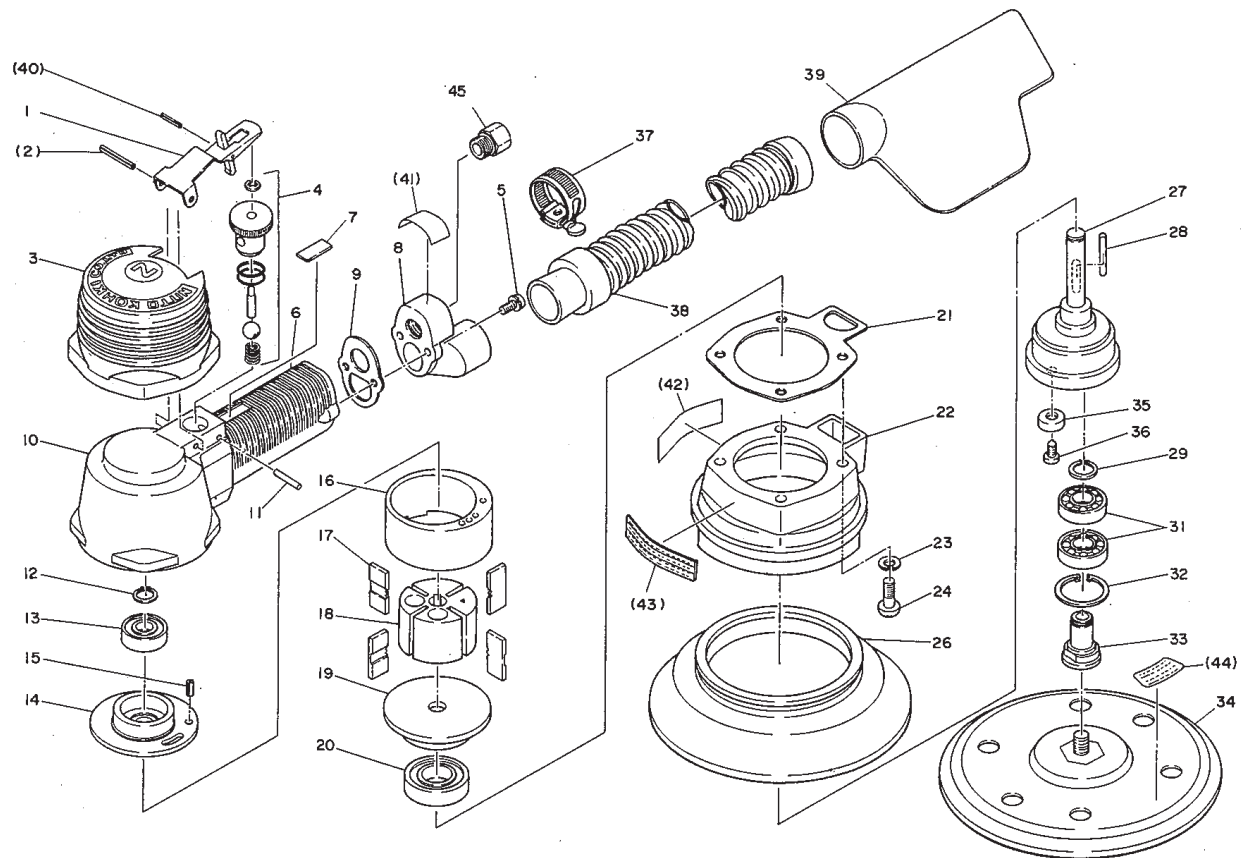

The part numbers with () are included in the Ass'y parts written above them.

No.	Part No.	Description	Qty	Price
1	TB02151	Throttle Lever Ass'y	1 set	
2	(TP01802)	Spring Pin 3×28 AW	1	
40	(TP05498)	Spring Pin 2×16 AW	1	
3	TP14808	Housing Cover	1	
4	TA99063	Throttle Valve Ass'y	1 set	
5	LP30942	Pan Head Screw 4×14	2	
6	TP14810	Grip Tube	1	
7	TQ02790	Lever Wear Plate	1	
8	TB02276	Rear Cap Ass'y	1 set	
41	(TQ12752)	Warning Label CE Mark	1	
9	TP14804	Gasket A	1	
10	TP14809	Housing	1	
11	TP20537	Needle Roller 3×21.8	1	
12	TP04595	External Retaining Ring C-10	1	
13	TP01913	Ball Bearing 6000ZZ	1	
14	TP14817	End Plate A	1	
15	TP08932	Spring Pin 4×8 AW	1	
16	TP14820	Cylinder	1	
17	TA9A288	Blade Ass'y (4 pcs)	1 set	
18	TP05980	Rotor	1	
19	TP14818	End Plate B	1	
20	TQ01504	Ball Bearing 6003LLB	1	
21	TP14811	Gasket B	1	
22	TB02218	Base Cover Ass'y	1 set	
42	(TQ02915)	Label Warning OSV-60A	1	
43	(TQ02923)	Plate Model Number OSV-60A	1	

No.	Part No.	Description	Qty	Price
23	TP00513	Spring Washer M5	4	
24	LP30138	Pan Head Screw 5×14	4	
26	TP14875	Cover 6"	1	
27	TP14869	Counter shaft	1	
28	TP14822	Parallel Key 2.5×3.8×20	1	
29	TP03546	External Retaining Ring C-12	1	
31	TP05650	Ball Bearing 6001D	2	
32	TP01036	Internal Retaining Ring C-28	1	
33	TP05984	Spindle	1	
34	TB03898	Pad 6" L-6H Ass'y [OSV]	1 set	
44	(TP16713)	Label Caution	1	
35	TP14876	Weight	1	
36	TP05986	Flat Fillister Head Screw 5×8	1	
45	TQ00857	Bushing M16×Rc1/4	1	

ACCESSORIES

No.	Part No.	Description	Qty	Price
	TP00474	Spanner 17	1	
	TP02236	Bushing R1/4×NPT1/4	1	
	TP14842	Brush	1	
38	TP14835	Hose	1	
39	TP14836	Dust Bag	1	
37	TP05662	Hose Band	1	
	TQ12758	Instruction Manual	1	
	TQ12759	Declaration of Conformity	1	

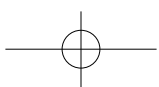
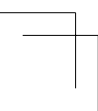
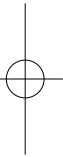
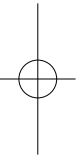
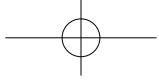
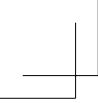



Overseas Affiliates / Offices

NITTO KOHKI U.S.A., INC.
46 Chancellor Drive, Roselle, IL 60172 U.S.A.
Tel:(1)-630-924-9393 Fax:(1)-630-924-0303

NITTO KOHKI EUROPE CO., LTD.
Unit 21, The Empire Centre Imperial Way,
Watford Herts, WD24 4TS, U.K.
Tel:(44)-1-923-239668 Fax:(44)-1-923-248815

NITTO KOHKI DEUTSCHLAND GMBH
Lerchenstr.47 D-71144 Steinenbronn, Germany
Tel:(49)-7-157-22436 Fax:(49)-7-157-22437

NITTO KOHKI CO., LTD., SINGAPORE BRANCH
10 UBI CRESCENT #01-62,
UBI TECHPARK LOBBY D, SINGAPORE 408564,
Tel:(65)-6227-5360 Fax:(65)-6227-0192

NITTO KOHKI AUSTRALIA PTY. LTD.
77 Brandl St., Brisbane Technology Park,
Eight Mile Plains QLD 4113 Australia
Tel:(61)-7-3340-4600 Fax:(61)-7-3340-4640

NITTO KOHKI CO., LTD.,
BANGKOK REPRESENTATIVE OFFICE
M&A Business Center 38Q. House Convent Bldg.,
7th Floor, Unit 7A, Convent Rd., Silom, Bangrak,
Bangkok 10500 Thailand
Tel:(66)-2-632-0307 Fax:(66)-2-632-0308

NITTO KOHKI (SHANGHAI) CO., LTD.
Room1506, suite C, Orient International Plaza,
NO85 LouShanGuan Road,Shanghai, 200336, CHINA
Tel:(86)-21-6415-3935 Fax:(86)-21-6472-6957

NITTO KOHKI CO., LTD.,
SHENZHEN REPRESENTATIVE OFFICE
2005C Shenzhen ICC Tower, Fuhuasanlu 168, Futian District,
Shenzhen, Guangdong, 518048 China
Tel:(86)-755-8375-2185 Fax:(86)-755-8375-2187

EC DECLARATION OF CONFORMITY
We hereby declare that the following our product conforms with the essential health and safety requirements of EU Directives.
Product: PNEUMATIC ORBITAL SANDER
Model: ORBITAL SANDER: OSV-60A
Serial No: In the case of 6 digits serial number.
XXXXXXXX
Consecutive numbers (00001~99999)
Last digit (0-9) of year (A.D.)
In the case of 7 digits serial number.
XXXXXXXXX
Consecutive numbers (00001~99999)
Last two digits (00-99) of year (A.D.)
Manufacturer: NITTO KOHKI Co., Ltd.
2-9-4, Nakaikegami, Ohta-ku, Tokyo, 146-8555, Japan
Authorised person to prepare the technical construction file(TCF) in the community:
Masatoshi Ogue
President
NITTO KOHKI EUROPE Co., Ltd.
Unit21, Empire Centre, Imperial Way, Watford Hertfordshire,
WD24 4TS, UK
Tel:(44)-01923-239668 Fax:(44)-01923-248815
Directive: 2006/42/EC Machinery Directive
The above product has been evaluated for conformity with above directives using the following European standards. The technical construction file (TCF) for this product is retained at the above manufacturer's location.
Machinery Directive: EN ISO12100:2010, EN ISO11148-8:2012, others
Sound Pressure/Power Level: EN ISO15744:2008, EN ISO4871:1996
Vibration Level: EN28927-3:2009
Signature: K. Kishi
Date/Place: Oct. 17, 2012 /Tokyo, Japan
Name: K.Kishi
Title: GENERAL MANAGER MACHINE TOOLS DIV.
NITTO KOHKI Co., Ltd.
2-9-4, Nakaikegami, Ohta-ku, Tokyo, 146-8555, Japan
Being the responsible person appointed and employed the manufacturer.
TQ12759-1