



27-GALLON SELF-EVACUATING PORTABLE OIL DRAIN USER'S MANUAL

Part No. JDI-27DC

FOR WARRANTY INFORMATION, PLEASE CALL 800-433-0708

DATE OF PURCHASE: _____

READ AND SAVE THIS MANUAL

FOR SERVICE ASSISTANCE, CALL 800-433-0708 OR VISIT JOHNDOW.COM



Important Safety Information

Read this manual and safety information before using this tank.



DANGER

Indicates a hazardous situation that, if not avoided, could result in death or serious injury.

- Hot automotive fluids can burn and injure eyes and body.
- Opening a hot system can cause these fluids to forcibly spray in all directions.
- Used motor oil is flammable. Keep away from flames, sparks, and other sources of ignition.
- DO NOT exceed 10 PSI (0.7 bar) supply pressure.



CAUTION

Indicates a hazardous situation that, if not avoided, could result in minor or moderate injury.

- Wear proper safety equipment and clothing, and safety glasses/goggles.
- Position the oil drain under the anticipated fluid stream and adjust as necessary until all fluids are collected.
- Be aware of natural wind, fans or other factors that may alter the fluid stream and cause injury or contamination of the surroundings.

NOTICE

Indicates information considered important, but not hazard-related.

- Monitor fluid level in drain. DO NOT overfill.
- Closely monitor the flow out of the discharge hose to prevent spills when evacuating oil from the drain.
- Tank should be in good condition with no visible leaks. Repair leaks and clean up spills and properly dispose of waste material.
- Close all valves when not filling or emptying the oil drain.

U.S. ENVIRONMENTAL REGULATIONS

Certain automotive fluids are considered to be compatible for recycling used oil per the US Environmental Agency (EPA). Do not mix other types of fluid with used motor oil. You must handle other types of fluid separately. See definitions below:

Used Oil Includes:

- Synthetic Oil
- Engine Oil
- Transmission Oil
- Brake Fluid
- Hydraulic Oil
- Cutting/Metal Oils

Used Oil Does Not Include:

- Antifreeze
- Gasoline
- Kerosene
- Petroleum Distillates and Solvents
- Vegetable or Animal Oils

CAPACITY AND DIMENSIONS

Product Specification	JDI-27DC	Material	Roto-molded polyethylene
Gallons	27 gallons	Wheel Size	4" Casters
Funnel Size	16"	Height Adjustment	45" to 70"
Measurement	21"W x 40"L x 23"H	Weight	55 lbs.

GETTING STARTED

Before assembly, ensure you have all parts according to the contents list. If any parts are missing or damaged, contact us for replacement.

CONTENTS

Item No.	Description	Qty.
1	Poly Drain Assembly	1
2	4" Caster Wheels	4
3	1/4" x 3/4" Bolts (not shown)	4
4	3/4" Washers (not shown)	4
5	Fluid Level Gauge Assembly	1
6	Drain Tube w/Collar & Height Adjustment Tool	1
7	3/4" Ball Valve	1

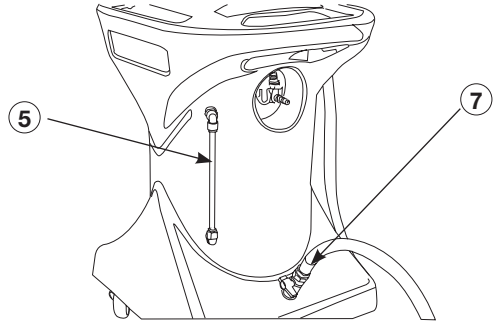
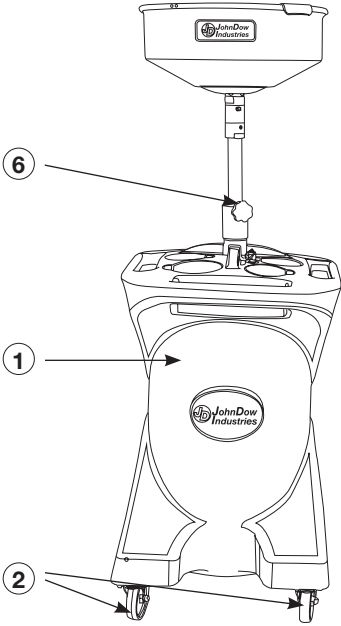

ASSEMBLY INSTRUCTIONS

- Caster Assembly:** Attach the casters to the drain using the bolts and washers provided (Figure 1).
- Drain Tube:** Insert the drain tube into the neck of the drain and secure by threading the drain tube coupler to the threaded drain tube neck, but not overly tight (Figure 2).
- Funnel:** Attach the funnel coupler to the threaded neck on the funnel (Figure 3).
 - Insert the funnel into the swivel fitting on top of the drain tube (Figure 4).
 - Tighten set-screw to secure funnel.
- Drain Hose:** Thread the hose assembly into the ball valve at the bottom of the tank (Figure 5).

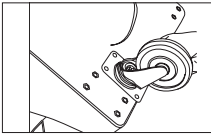

Figure 1

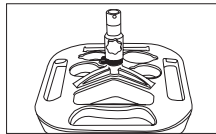

Figure 2

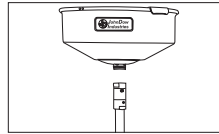

Figure 3



Figure 4



Figure 5

OPERATION

1. To raise or lower the funnel, loosen the funnel height adjustment knob and move the drain tube up or down to desired height (Figure 6).
2. Make sure the lower ball valve is closed before use.
3. Periodically check fluid level gauge to see the amount of recovered oil in the tank. Never fill the tank over maximum level given by the level indicator (Figure 7).

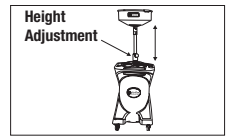

Figure 6

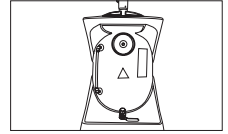

Figure 7

TO EVACUATE OIL FROM THE DRAIN TO USED OIL STORAGE TANK

1. Position the drain next to the used oil storage tank. Secure the discharge hose to the used oil storage tank (A secure hose is important when the discharge process begins).
2. Open the lower ball valve (Figure 8).
3. Connect the air supply and open the air control valve to begin the evacuation process. The auto-check valve will automatically seal during evacuation.

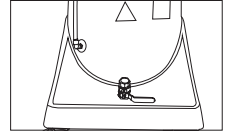

Figure 8

NOTE: The air regulator is preset at 7 psi and cannot be adjusted. The air supply should not exceed 7 psi.

NOTE: Thread quick disconnect air coupler (not included) compatible with your shop supply air into the 1/4" end of the air control valve.

When drain is completely empty, close the air control valve and disconnect the air supply. Close the lower valve, disconnect the discharge hose.