

DAILY REFERENCE GUIDE



THANK YOU FOR PURCHASING A WHIRLPOOL PRODUCT

To receive more comprehensive help and support, please register your product at www.whirlpool.eu/register



You can download the Safety Instructions and the Use and Care Guide by visiting our website docs.whirlpool.eu and following the instructions on the back of this booklet.



Before using the appliance carefully read the Health and Safety guide.

PRODUCT DESCRIPTION

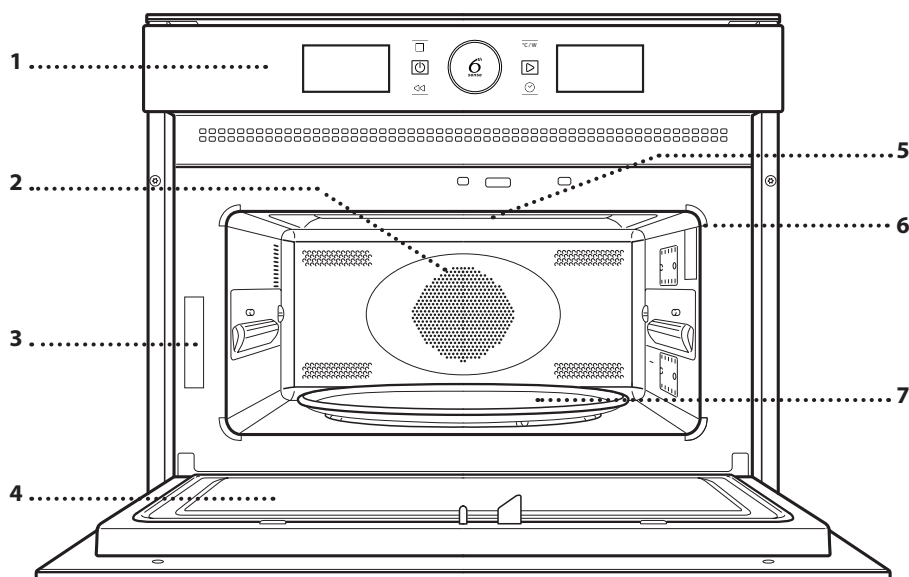

1. Control panel
2. Circular heating element (non-visible)
3. Identification plate (do not remove)
4. Door
5. Upper heating element/grill
6. Light
7. Turntable

CONTROL PANEL

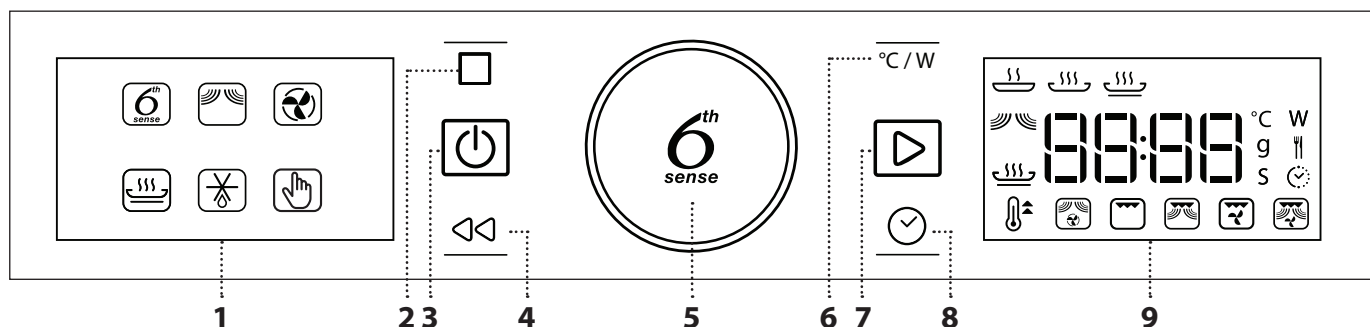

1. LEFT-HAND DISPLAY

2. PAUSE

To pause a cooking cycle

3. ON/OFF

For switching the oven on and off and for stopping an active function at any time.

4. BACK

For returning to the previous screen.

5. ROTARY KNOB / 6th SENSE BUTTON

Turn this to navigate through the functions and adjust all of the cooking parameters. Press  to select, set, access or confirm functions or parameters and eventually start the cooking program.

6. POWER

To adjust the temperature, grill level or microwave power.

7. START

For starting functions and confirming settings

8. TIME

For setting the time as well as setting or adjusting the cooking time.

9. RIGHT-HAND DISPLAY

ACCESSORIES

TURNTABLE

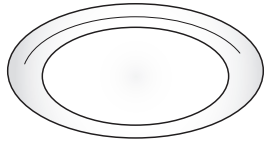

Placed on its support, the glass turntable can be used with all cooking methods. The turntable must always be used as a base for other containers or accessories, with the exception of the rectangular baking tray.

TURNTABLE SUPPORT

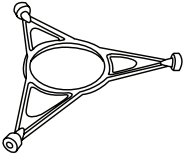

Only use the support for the glass turntable. Do not rest other accessories on the support.

CRISP PLATE

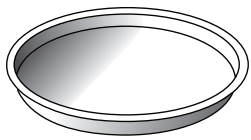

Only for use with the designated function. The Crisp plate must always be placed in the centre of the glass turntable and can be pre-heated when empty, using the special function for this purpose only. Place the food directly on the Crisp plate.

HANDLE FOR CRISP PLATE

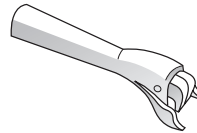

Useful for removing the hot Crisp plate from the oven.

WIRE RACK

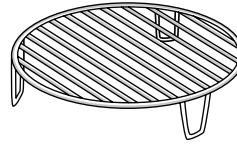

surfaces.

This allows you to place food closer to the grill, for perfectly browning your dish. Place the wire rack on the turntable, making sure that it does not come into contact with other

RECTANGULAR BAKING TRAY

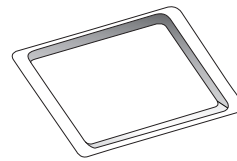

in the cooking compartment.

Only use the baking plate with functions that allow for convection cooking; it must never be used in combination with microwaves. Insert the plate horizontally, resting it on the rack

Please note: You do not need to remove the turntable and its support when using the rectangular baking plate.

The number and type of accessories may vary depending on which model is purchased. Other accessories that are not supplied can be purchased separately from the After-sales Service.

There are a number of accessories available on the market. Before you buy, ensure they are suitable for microwave use and resistant to oven temperatures.

Metallic containers for food or drink should never be used during microwave cooking.

Always ensure that foods and accessories do not come into contact with the inside walls of the oven.

Always ensure that the turntable is able to turn freely before starting the oven. Take care not to unseat the turntable whilst inserting or removing other accessories.

FUNCTIONS





6th SENSE FUNCTIONS

With the 6th Sense functions, simply select the type and weight or the quantity of the food items to obtain the best results. The oven will automatically calculate the optimum settings and continue to change them as cooking progresses.

The total time does not include preheating phases.





6th SENSE REHEAT

For reheating ready-made food that is either frozen or at room temperature. The oven automatically calculates the settings required to achieve the best results in the shortest amount of time. Place food on a microwave-safe and heatproof dinner plate or dish.

CATEGORY	FOOD	WEIGHT
	DINNER PLATE	250 - 500 g
	FROZEN PORTION	250 - 500 g
	FROZEN LASAGNA	250 - 500 g
	SOUPS	200 - 800 g
	BEVERAGES	1 - 5 dl

6th SENSE COOK

For cooking foods quickly and achieving optimal results. Use a heatproof container suitable for microwave use.

CATEGORY	FOOD	WEIGHT
	BAKED POTATOES (Turn when prompted)	200 g - 1 kg
	FRESH VEGETABLES (Cut into pieces of equal size and add 2 to 4 tablespoons of water. Cover)	200 - 800 g
	FROZEN VEGETABLES (Turn when prompted. Cover)	200 - 800 g
	CANNED VEGETABLES	200 - 600 g
	POPCORN	100 g

6th SENSE CRISP

For quickly reheating and cooking frozen foods and giving them a golden, crunchy top. Only use this function with the crisp plate provided. Turn the food when prompted.

CATEGORY	FOOD	WEIGHT
	FRENCH FRIES (Spread out in a single layer and sprinkle with salt before cooking)	200 - 600 g
	PIZZA, THIN CRUST	200 - 500 g
	PIZZA, THICK CRUST	300 - 800 g
	CHICKEN WINGS, CHICKEN PIECES (Lightly oil the plate)	200 - 600 g
	FISH FINGERS (Crisp plate must be preheated)	200 - 600 g

Required accessories: Crisp plate, handle for crisp plate

MICROWAVE

For quickly cooking and reheating food or drinks.

POWER	RECOMMENDED FOR
900 W	Quickly reheating drinks or other foods with a high water content
750 W	Cooking vegetables
650 W	Cooking meat and fish
500 W	Cooking meaty sauces, or sauces containing cheese or egg. Finishing off meat pies or pasta bakes
350 W	Slow, gently cooking. Perfect for melting butter or chocolate
160 W	Defrosting frozen foods or softening butter and cheese
90 W	Softening ice cream

FORCED AIR

For cooking dishes in a way that achieves similar results to using a conventional oven. The baking plate or other cookware that is suitable for oven use can be used to cook certain foods.

Recommended accessories: Rectangular baking plate, wire rack



CRISP

For perfectly browning a dish, both on the top and bottom of the food. This function must only be used with the special Crisp plate.

Required accessories: Crisp plate, handle for the Crisp plate



JET DEFROST

For quickly defrosting various different types of food simply by specifying their weight. Food should be placed directly on the glass turntable. Turn the food when prompted.

CATEGORY	FOOD	WEIGHT
	MEAT (mince, cutlets, steaks, roasting joints)	100 g - 2 kg
	POULTRY (whole chicken, pieces, fillets)	100 g - 2.5 kg
	FISH (whole, steaks, fillets)	100 g - 2 kg
	VEGETABLES (mixed vegetables, peas, broccoli etc.)	100 g - 2 kg
	BREAD (loaves, buns, rolls)	100 g - 1 kg



MANUAL FUNCTIONS



QUICK HEAT

For quickly reheating the oven before a cooking cycle. Wait for the function to finish before placing food inside the oven.



FORCED AIR + MICROWAVE

To prepare oven dishes in a short time.

Required accessories: wire rack



GRILL

For browning, grilling and gratins. We recommend turning the food during cooking. For best results, preheat the grill for 3-5 minutes.

Required accessories: wire rack



GRILL + MW

For quickly cooking and gratinating dishes, combining the microwave and grill functions.

Required accessories: wire rack



TURBO GRILL

For perfect results, combining the grill and convection oven functions. We recommend turning the food during cooking.

Required accessories: wire rack



TURBO GRILL + MW

For quickly cooking and browning your food, combining the microwave, grill and convection oven functions.

Required accessories: wire rack

FIRST TIME USE

. SETTING THE TIME

You will need to set the time when you switch on the oven for the first time.



The two digits for the hour will start flashing: Turn the knob to set the hour and then press to confirm.





The two digits for the minutes will start flashing. Turn the knob to set the minutes and press to confirm.

Please note: To change the time at a later point, press and hold for at least one second while the oven is off and repeat the steps above.

You may need to set the time again following lengthy power outages.

DAILY USE

1. SELECT A FUNCTION

When the oven is off, only the time is shown on the display. Press and hold  to switch the oven on. Turn the *knob* to view the main functions available on the left-hand display. Select one and press .



To select a sub-function (where available), select the main function and then press  to confirm and go to the function menu.



Turn the *knob* to select from amongst the subfunctions available on the right-hand display and then press .



2. SET A FUNCTION

. AUTOMATIC FUNCTIONS / JET DEFROST

FOOD CLASS

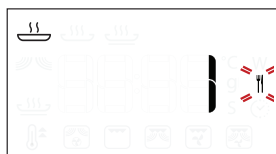
Once you have chosen one of the automatic functions, you will need to select a category for the food you are cooking.





When the  icon flashes, turn the *knob* to select the category you require and then press .

WEIGHT

To achieve the best results, the automatic functions (and Jet Defrost) require you to enter the weight of the food, selecting from amongst the default settings: the oven will calculate the ideal length of time for the function to run for each category of food.



When the default setting appears on the display and the  icon flashes, turn the *knob* to set the weight and then press .

. MANUAL FUNCTIONS

After having selected the function you require, you can change its settings.

The display will show the settings that can be changed in sequence.

MICROWAVE POWER / TEMPERATURE



When the **W** icon flashes on the display, turn the *knob* to adjust the power setting and then press  to confirm and continue to alter the settings that follow (if possible).

Please note: Once the function has been activated, the power can be changed by pressing  to access the settings menu, then turning the *knob* to change the setting.

GRILL POWER



There are three defined power levels for grilling: 1 (low), 2 (mid), 3 (high). The default value is displayed between two flashing "-" symbols.



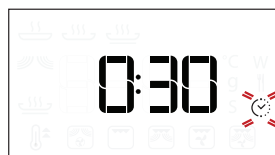

Turn the knob to set the desired grill level, then press  to confirm.

DURATION



When the  icon flashes on the display, use the *knob* to set the cooking time you require and then press  to confirm.

You do not have to set the cooking time if you want to manage cooking manually: Press  to confirm and start the function.

Note: During cooking, you can adjust the cooking time by turning the *knob*; each time you press , the cooking time increases by 30 seconds.

QUICK HEAT

Select the function, then use the *knob* to set the target temperature you require and press  to confirm and start the function.





When the oven reaches the target temperature a buzzer sound.

Please note: It is advisable to do not put the food into the oven before the end of this function.

3. ACTIVATE THE FUNCTION

Once you have applied the settings you require, press  to activate the function.

Every time the  button is pressed again, the cooking time will be increased by a further 30 seconds.

Please note: You can press  at any time to stop the function that is currently active.

. JET START

When the oven is switched off, it is possible to press  to activate cooking with the microwave function set at full power (900 W) for 30 seconds.

. SAFETY LOCK

This function is automatically activated to prevent the oven from being switched on accidentally.

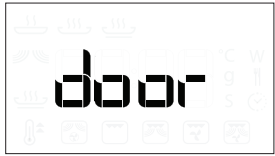

Open and close the door, then press  to start the function.

4. PAUSE

To pause an active function, for example to stir or turn the food, simply open the door.

To start it up again, close the door and press .

AUTOMATIC PAUSE
(STIR OR TURN THE FOOD)

Certain functions will pause to allow you to turn or stir the food.



Once the oven has paused cooking, open the door and carry out the action you are prompted to perform before closing the door again and pressing  to continue with cooking.

5. COOKING END TIME

An audible signal will sound and the display will indicate that cooking is complete.



To extend the cooking time without changing the settings, turn the *knob* to set a new cooking time and press .

. COOLING DOWN

When a function with hot air is finished, the appliance may carry out a cooling procedure.

The display shows "Cool On".

After this procedure, the oven automatically switches off.

Please note: the cooling procedure can be interrupted by opening the door and will be eventually reactivated, if needs, by closing it again.

. KEY LOCK

To lock the keypad, press and hold  for at least 5 seconds.







































































Do this again to unlock the keypad.

Please note: The key lock can also be activated while cooking is in progress.









For safety reasons, the oven can be switched off at any time by pressing and holding .

COOKING TABLE

FOOD	FUNCTION	PREHEAT	TEMP. (°C)	POWER (W)	DURATION	ACCESSORIES
Leavened cakes		-	160 - 180	-	30 - 60	 
		-	160 - 180	90	25 - 50	 
Filled pies (cheesecake, strudel, apple tart)		Yes	160-190	-	35 - 70	 
Cookies		Yes	170-180	-	10 - 20	
Meringues		Yes	100-120	-	40 - 50	
Rolls		Yes	210-220	-	10 - 12	
Bread Loaf		Yes	180-200	-	30 - 35	
Pizza / Pie		Yes	190-220	-	20 - 40	
Pizza (0.4-0.5 Kg)		-	-	-	14 - 16	
Savoury pies (vegetable pie, quiche Lorraine)		Yes	180-190	-	40 - 55	 
Quiche lorraine (1-1.2 Kg)		-	-	-	18 - 20	
Lasagna / Baked pasta		-	-	350 - 500	15 - 40	 
Roast lamb / Veal / Roastbeef (1.3-1.5 Kg)		-	170-180	-	70 - 80*	 
		-	160-180	160	50 - 70*	 
Roastbeef - medium (1.3-1.5 Kg)		-	170-180	-	40 - 60*	 
Roast Chicken / Rabbit / Duck (whole 1-1.2 Kg)		-	210-220	-	50 - 70*	 
		-	210-220	350	45 - 60*	 
Chicken / Rabbit / Duck (fillets/pieces 0.4-1 Kg)		-	-	350 - 500	20 - 40*	 
		-	-	-	12 - 18	
Baked fish (whole)		-	-	160 - 350	20 - 40	 
Fish fillets / slices		Yes	-	-	15 - 30*	 
Stuffed vegetables (tomatoes, courgette, aubergines...)		-	-	500 - 650	25 - 50	 
Toast		-	-	-	3 - 6	
Sausages / Kebabs / Spare ribs / Hamburgers		-	-	-	20 - 40*	
Sausages / Hamburger (0.2-1 Kg)		Yes**	-	-	6 - 16	
Baked potatoes		-	-	350 - 500	20 - 40*	
Potatoes wedges (0.3-0.8 Kg)		-	-	-	10 - 20	
Baked fruit		-	-	160 - 350	15 - 25	 
Vegetable gratin		-	-	-	15 - 25	 
Fried vegetables (0.3-0.8 Kg)		Yes**	-	-	8 - 18	

* Turn the food halfway through cooking.

** Preheat the Crisp plate for 3-5 minutes.

FUNCTIONS	Crisp 	Forced air 	Forced air + MW 	Grill 	Grill + MW 
ACCESSORIES	Heatproof plate/container suitable for use in microwaves 	Wire rack 	Rectangular baking tray 	Crisp plate 	

CLEANING

Make sure that the appliance has cooled down before carrying out any maintenance or cleaning.
Do not use steam cleaners.

Do not use wire wool, abrasive scourers or abrasive/corrosive cleaning agents, as these could damage the surfaces of the appliance.

INTERIOR AND EXTERIOR SURFACES

- Clean the surfaces with a damp microfibre cloth. If they are very dirty, add a few drops of pH-neutral detergent. Finish off with a dry cloth.
- Clean the glass in the door with a suitable liquid detergent.
- At regular intervals, or in case of spills, remove the turntable and its support to clean the bottom of the oven, removing all food residue.
- The grill does not need to be cleaned as the intense heat burns away any dirt. Use this function on a regular basis.

ACCESSORIES

All accessories are dishwasher safe with the exception of the Crisp plate.
 The Crisp plate should be cleaned using water and a mild detergent. For stubborn dirt, rub gently with a cloth. Always leave the Crisp plate to cool down before cleaning.

TROUBLESHOOTING

Problem	Possible cause	Solution
The oven is not working.	Power cut. Disconnection from the mains.	Check for the presence of mains electrical power and whether the oven is connected to the electricity supply. Turn off the oven and restart it to see if the fault persists.
The oven makes noises, even when it is switched off.	Cooling fan active.	Open the door or hold  .
The display shows the letter "F" followed by a letter or number.	Software fault.	Contact your nearest After-sales Service Centre and state the letter or number that follows the letter "F".

PRODUCT FICHE

 [www](http://www.docs.whirlpool.eu) The product fiche with energy data of this appliance can be downloaded from the website docs.whirlpool.eu

HOW TO OBTAIN THE USE AND CARE GUIDE

>  [www](http://www.docs.whirlpool.eu) Download the Use and Care Guide from our website docs.whirlpool.eu (you can use this QR Code), specifying the product's commercial code.



> Alternatively, contact our Client After-sales Service

CONTACTING OUR AFTER-SALES SERVICE

You can find our contact details in the warranty manual. When contacting our Client After-sales Service, please state the codes provided on your product's identification plate.

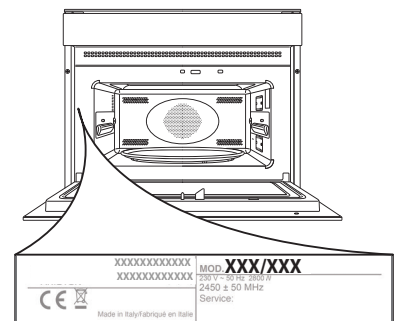

400011091756

Printed in Italy