



# ICI

---

INFRARED CAMERAS INC

## FMX 320/FMX 640/FMX HT 640 SERIES QUICK START GUIDE

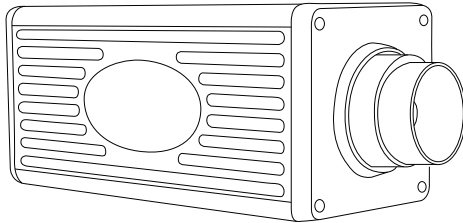

ICI cameras fall under US Federal Law and Export Control.

2105 W. Cardinal Dr. Beaumont, TX 77705  
Phone: (409) 861-0788  
Toll Free: (866) 861-0788  
infraredcameras.com  
support@infraredcameras.com  
We Are IR™

©Copyright 2021, Infrared Cameras, Inc. - All rights reserved. The contents of this document may not be reproduced in whole or in parts without the written consent of the copyright owner.

Printed in the United States of America.

2105 W. Cardinal Dr.  
Beaumont, TX 77705  
(866) 861-0788  
[www.infraredcameras.com](http://www.infraredcameras.com)

Revision: 5.2021-001

THE MANUFACTURER RESERVES THE RIGHT TO ALTER THE SPECIFICATIONS OF THE PRODUCT WITHOUT PRIOR NOTIFICATION. THE MANUFACTURER ALLOWS HIMSELF THE RIGHT TO MODIFY WITHOUT ANY PRELIMINARY OPINION THE TECHNICAL SPECIFICATIONS OF THE PRODUCT. THIS MANUAL MAY CONTAIN TECHNICAL INACCURACIES OR TYPOGRAPHICAL ERRORS.

NOTICE ALL STATEMENTS, INFORMATION, AND RECOMMENDATIONS IN THIS MANUAL ARE BELIEVED TO BE ACCURATE BUT ARE PRESENTED WITHOUT WARRANTY OF ANY KIND. NOTWITHSTANDING ANY OTHER WARRANTY HEREIN, ALL DOCUMENT FILES AND SOFTWARE ARE PROVIDED "AS IS" WITH ALL FAULTS. ICI DISCLAIMS ALL WARRANTIES, EXPRESSED OR IMPLIED, INCLUDING, WITHOUT LIMITATION, THOSE OF MERCHANTABILITY, FITNESS FOR A PARTICULAR PURPOSE AND NONINFRINGEMENT OR ARISING FROM A COURSE OF DEALING, USAGE, OR TRADE PRACTICE.

THE SOFTWARE LICENSE AND LIMITED WARRANTY FOR THE ACCOMPANYING PRODUCT ARE SET FORTH IN THE INFORMATION PACKET THAT SHIPPED WITH THE PRODUCT AND ARE INCORPORATED HEREIN BY THIS REFERENCE. IF YOU ARE UNABLE TO LOCATE THE SOFTWARE LICENSE OR LIMITED WARRANTY, CONTACT YOUR ICI REPRESENTATIVE FOR A COPY.

IN NO EVENT SHALL ICI BE LIABLE FOR ANY INDIRECT, SPECIAL, CONSEQUENTIAL, OR INCIDENTAL DAMAGES, INCLUDING, WITHOUT LIMITATION, LOST PROFITS OR LOSS OR DAMAGE TO DATA ARISING OUT OF THE USE OR INABILITY TO USE THIS MANUAL, EVEN IF ICI HAS BEEN ADVISED OF THE POSSIBILITY OF SUCH DAMAGES.

## Package Includes

---

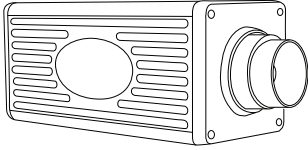

FMX Series IR Camera

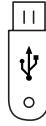

Software USB Drive

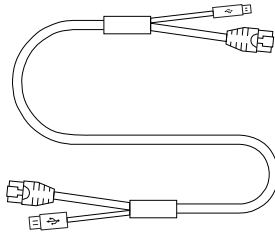

Option 1: Combo Cable

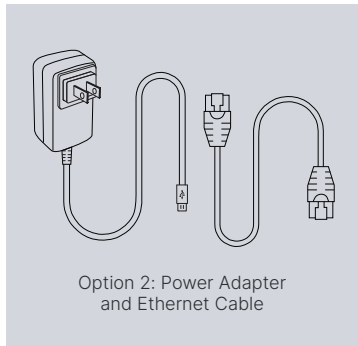

Option 2: Power Adapter  
and Ethernet Cable

**ENSURE ALL SYSTEM EQUIPMENT AND COMPONENT ITEMS ARE PRESENT BEFORE BEGINNING INSTALLATION. PACKAGES WILL ARRIVE WITH EITHER A COMBO CABLE OR POWER ADAPTER/ ETHERNET CABLE BUNDLE BUT NOT BOTH.**

## Option 1: Set Up

---

A.

Mount the FMX Series IR Camera to a tripod using the 1/4-20 mount.

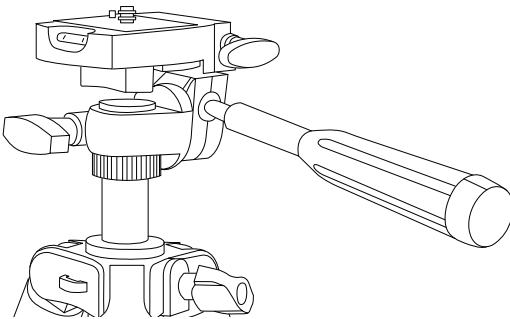
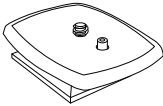
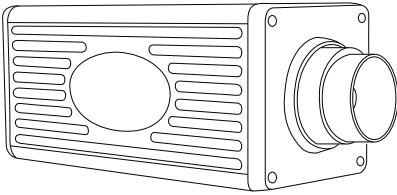

B.

Plug Mirco-USB end of the combo cable into the 5V DC port on the back of the FMX Series IR Camera.

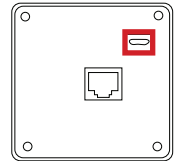
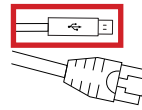

**MAKE SURE TRIPODS DO NOT BLOCK THE DIRECT PATH OF PERSON(S) TO BE IMAGED TO ENSURE THE EQUIPMENT WILL NOT BE MOVED OR KNOCKED DOWN. USING A DIVIDING BARRIER WILL HELP KEEP TRIPODS SEPARATE FROM THE PATH.**

C.

Plug the Ethernet combo cable (same side as the Micro-USB) into the FMX Series IR Camera Ethernet port.

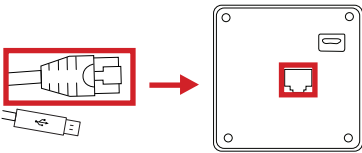

D.

Plug the other end of the Ethernet cable into the Ethernet port of the laptop computer.

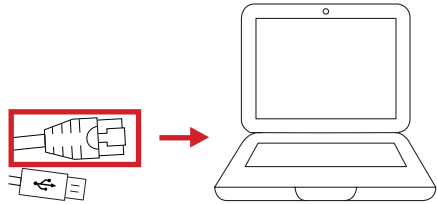

E.

Plug USB into an open USB port of the laptop computer.

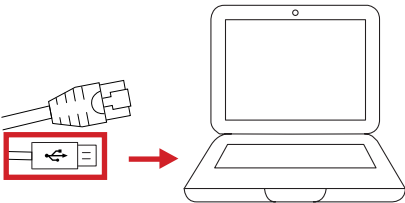

F.

Power on devices.

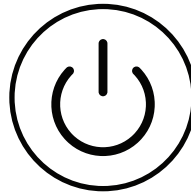

## Option 2: Set up

---

**SOME FMX SERIES IR CAMERA PACKAGES WILL COME WITH A POWER ADAPTER AND ETHERNET CABLE INSTEAD OF A COMBO CORD. COMPLETE STEP A FOR OPTION ONE SETUP BEFORE CONTINUING WITH THE FOLLOWING STEPS.**

**B.**

Plug the Ethernet cable into the FMX Series IR Camera Ethernet port.

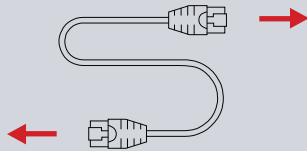
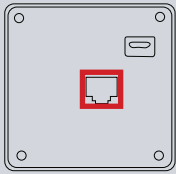

**C.**

Plug the other end of the Ethernet cable into the Ethernet port of the laptop computer.

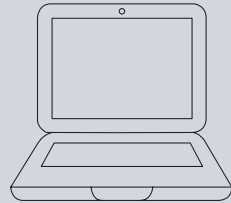

**D.**

Plug Mirco-USB end of the combo cable into the 5V DC port on back of FMX Series IR Camera.

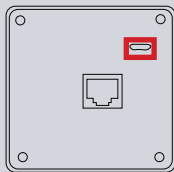
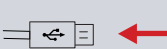

**E.**

Plug power cord into a 110/120V electrical outlet.

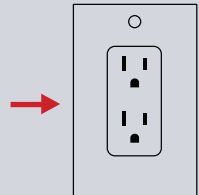
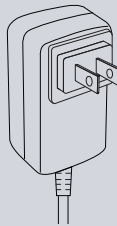

G.

Power on devices.



## Software

---

A.

Install IR Flash software using the software USB drive. Refer to the IR Flash User Manual for instructions.

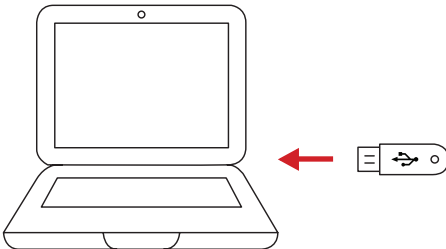

B.

Once installed, launch IR Flash software by double-clicking the associated desktop icon.

## ABOUT ICI / CONTACT

---

Infrared Cameras, Inc.  
2105 W. Cardinal Dr.  
Beaumont, TX 77705

Phone: (409) 861-0788 | Toll Free: (866) 861-0788 | International: (409) 861-0788

General Inquiry: [support@infraredcameras.com](mailto:support@infraredcameras.com)

Website: [www.infraredcameras.com](http://www.infraredcameras.com)

You may reach a representative by phone or email Mon – Fri 8:00AM – 5:00PM CST.

ICI manufactures complete systems and software. We can provide complete engineering, software, and OEM solutions. Our Fortune 500 clients rely on us for infrared equipment and thermography training (which we offer through the Infrared Training Institute).

In addition to providing custom germanium, silica, and sapphire optics, we also build windows for enclosures, as well as custom pan and tilt units. We can even provide customizable explosion-proof systems.

Our knowledge and experience stems from years of using infrared imaging and temperature measurement instruments to provide solutions to: managers, engineers, scientists, inspectors and operators in space, power companies, medical, pulp and paper, food industry, research and development, and various process industries. You can see our products and services used in industrial, commercial, and government applications worldwide. Originally named Texas Infrared (still DBA), Infrared Cameras, Inc. has been in business since March, 1995.

Thank you for your dedicated and continued support.